

NGT

USER MANUAL



Attach the
SN Code here

The SN Code of your scooter.
Please see P.7 and P.8 for
detailed information.

This owner's manual contains important safety, operational and maintenance information. Any person operating or riding as a passenger on your scooter should carefully read and fully understand the entire contents of this manual prior to riding the vehicle. For your safety, follow all safety warnings contained within the owner's manual and the labels applied to your scooter.

If you have any questions, please ask your dealer for assistance.



WARNING California Proposition 65

Lithium-ion Batteries and/or products that contain Lithium-ion Batteries can expose you to chemicals including cobalt, lithium, nickel oxide, and nickel, which are known to the State of California to cause cancer and birth defects or other reproductive harm.

For more information go to
www.P65Warnings.ca.gov

CONTENTS

| | |
|--|----|
| General Notice | 1 |
| Precautions | 2 |
| Safety Notice | 3 |
| Installation Guide..... | 4 |
| Downloading the App..... | 7 |
| Parts Info..... | 9 |
| Dashboard Display Info..... | 11 |
| Operation Guide..... | 14 |
| Battery Use and Maintenance Guide..... | 21 |
| DOs and DON'Ts while Riding | 27 |
| Maintenance and Repair..... | 29 |
| Regular Maintenance Checklist | 32 |
| Technical Parameters | 39 |
| Maintenance Record..... | 42 |
| Battery Recycling | 49 |
| Reporting Safety Defects | 50 |

General Notice

- △ Please read this User Manual carefully for proper operation before riding the scooter.
- △ For your safety, please check whether all parts of the scooter are in good working condition according to this User Manual before riding. Contact your dealer immediately in the event you encounter any problems.
- △ Please follow the traffic laws. Slow down on slippery roads in bad weather to allow greater braking distance for your safety.
- △ Please pay attention to deep water. It may cause corrosion or failure of the motor, battery, or other parts if water level reaches above the wheel axle.
- △ Do not dismantle the scooter on your own. Please contact your dealer for replacement or purchase of original parts.
- △ For the safety of others and to prevent unnecessary damage to your scooter, do not lend your scooter to those who are unfamiliar with it's operation.
- △ You should keep this owner's manual in your vehicle at all times and it should be considered a permanent part of the vehicle.

Precautions

- △ Rider and Passenger

This scooter is not designed for a ride of more than 2 persons.

- △ Road Conditions

This scooter is not designed for off-road use.

- △ This User Manual should be deemed as a permanent document of This scooter. If this scooter is transferred to others, this User Manual should also be handed over to the new owner.
- △ Reproduction or reprint of any part of this User Manual is strictly prohibited.

Attention: Do not exceed speed limit and apply brakes cautiously. Always use side stand or central stand when parking.

Warning: Failure to follow the instructions herein may lead to serious casualties, personal injury, or scooter damage.

Safety Notice

- △ Using a helmet and protective goggles is strongly advised.
- △ You are advised to take appropriate two-wheel vehicle operational and safety training before using this scooter.
- △ Please follow the Operation Guide (P.14) to fully understand how to properly operate the scooter.
- △ It should be noted that the braking distance in poor weather will significantly increase. Avoid braking on paint markers, manhole covers, and oil stains to prevent slipping. Pay extra attention when riding through railway crossings, junctions, tunnels, and bridges. Slow down if road conditions are unclear.
- △ Do not use high beam indiscriminately. Continuous use of high beam may disturb the vision of other drivers and pedestrians.
- △ Do not use mobile phones or other electronic devices which may draw your attention while riding.
- △ Do not lane change without signaling. Changing lanes at will is a primary cause of accidents. When you need to perform a lane change, remember to switch on the Turn Signal Indicator first. Always check the vehicles approaching from behind before changing lanes.

Installation Guide

- ① Insert the key to the main lock and turn to the icon of "OPEN" as shown in the figure to the right.

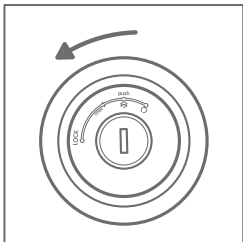

- ② Open the seat to remove the key, windshield package (with rubber pads and standard parts), and installation tools.

Insert the key into the keyhole in the rear storage and turn it to open the battery compartment. Take out the charger and rearview mirrors package inside.

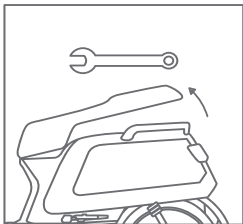

Installation Guide

- ③ Take out the rearview mirrors and check them carefully. Install the left rearview mirror into the mounting hole on the left brake lever and turn it clockwise. The bolt shall be screwed in for more than 15mm.

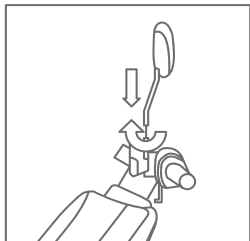

- ④ Adjust the rearview mirrors to an appropriate position and then tighten nuts on the rearview mirror with a spanner. Properly set the dust cover.

Install the right rearview mirror in the same way.

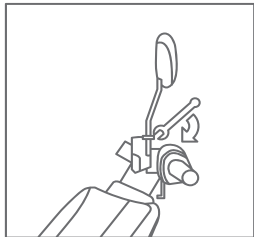

- ⑤ Align the windshield rubber part with the windshield holes and then install it.
- ⑥ Tighten the two screws with the screwdriver to secure the windshield.

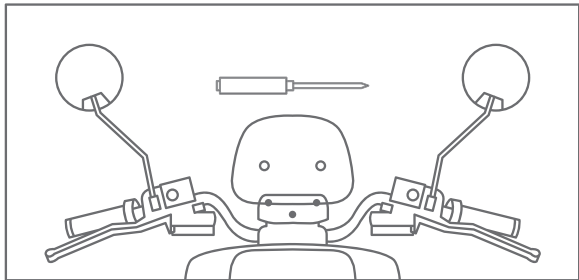

Downloading the APP

Functions such as checking battery level, locating, and management can be implemented on the electric scooter through the app.

- ① Scan the QR code below to download the APP titled *Niu E-Scooter*.



- ② Run Setup after downloading and register.
- ③ Please scan the QR code **on the inside of cover page** for app registration.

Note:

The mobile phone system is required to be at least Android 4.0 or iOS 8. Make sure that the mobile phone has been connected to the Internet when running the app (Wi-Fi / 2G / 3G / 4G).



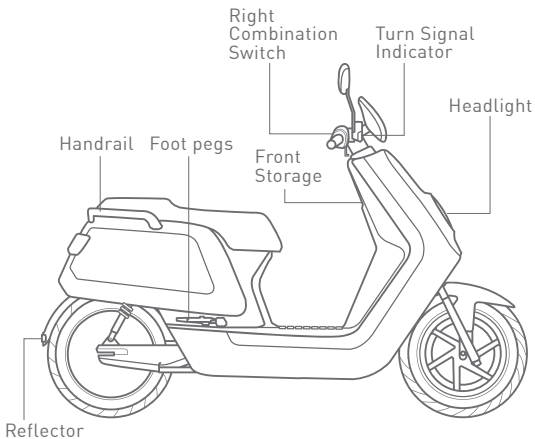

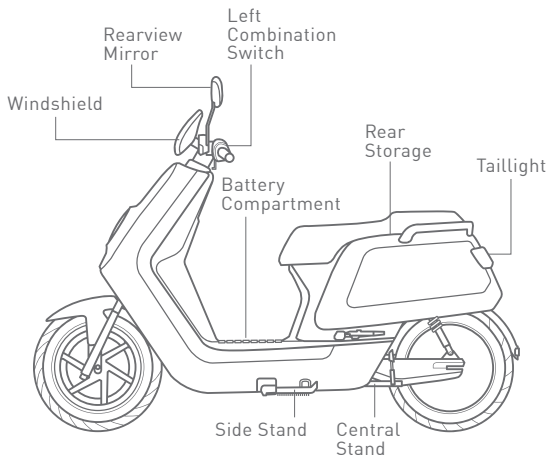



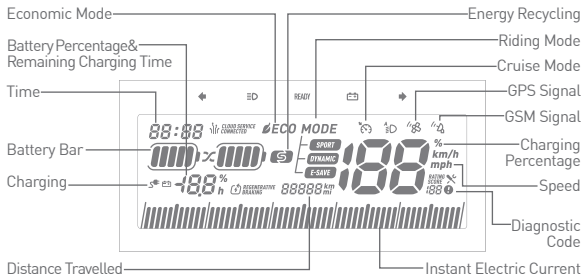
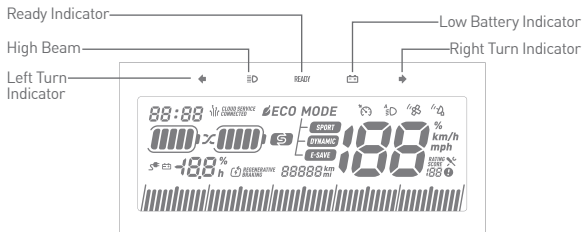



Parts Info













Dashboard Display Info



| | | |
|---|-------------------------|--|
|  | Left Turn Indicator | The Left Turn Indicator is on. |
|  | Right Turn Indicator | The Right Turn Indicator is on. |
|  | High Beam | The High Beam is on. |
|  | Ready Indicator | In Riding Mode. |
|  | Low Battery Indicator | Battery level less than 10%. |
|  | Time | Now is 10:00 |
|  | Economic Mode | Ideal energy consumption status. |
|  | GPS Signal | No flashing: Signal strong. Bars are flashing: Signal weak. |
|  | GSM Signal | Entire icon flashing: No signal. |
|  | Cruise Mode | The scooter is in Cruise Mode. |
|  | Diagnostic Code | The Diagnostic Code is 30. Please see P.34-37 for details. |
|  | Energy Recycling Status | Energy is being recycled from braking. |

Dashboard Display Info

| | | |
|---|-----------------------------|---|
|  | Battery Bar | Current battery level is 80~89%. |
|  | Battery Percentage (Small) | Current battery level is 85%. |
|  | Remaining Charging Time | The remaining charging time is 3.2h (using scooter charging port). |
|  | Charging | Battery is being charged. |
|  | Distance Travelled | Distance Travelled is 802km. |
|  | Instant Electric Current | Indicates instant power output. |
|  | Riding Mode | Energy Saving Mode Dynamic Mode Sport Mode |
|  | Speed | Current speed is 26km/h. |
|  | Charging Percentage (Large) | Current battery charging progress is 13% (using scooter charging port). |

Operation Guide

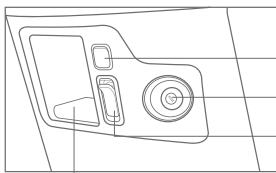

△ Front Storage Area

- ① USB Charging Port
- ② Main Lock
- ③ Hook
- ④ Front Storage

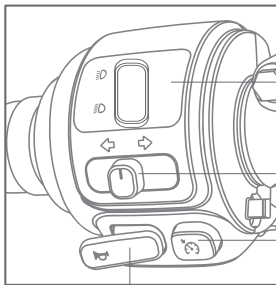

△ Left Combination Switch

- ① High/Low Beam Light
- ② Turn Signal Indicator
- ③ Cruising Mode
- ④ Horn

Operation Guide

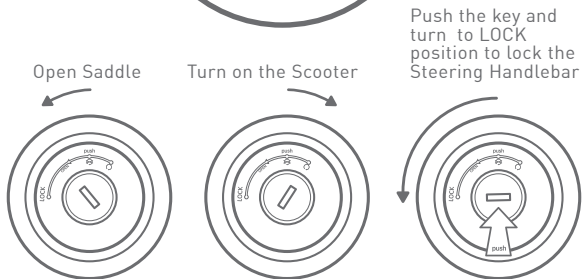
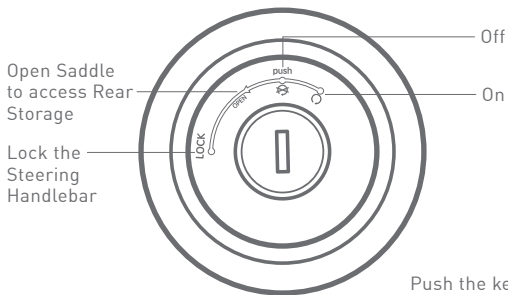

- ① High/Low Beam: Press the top part to switch to high beam; press the bottom part to switch to low beam.

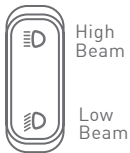

Remarks: To signal overtaking with flashing light, the rider may press and release the top part of the button repeatedly.

- ② Turn Signal Indicator: Push the button left to turn on the Left Turn Signal Indicator; push the button right to turn on the Right Turn Signal Indicator. Press the button to turn off.

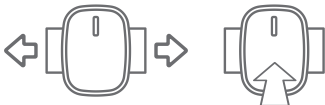

- ③ Cruising Mode: Push the button to cruise at current speed. Press again or brake to turn it off.



Operation Guide

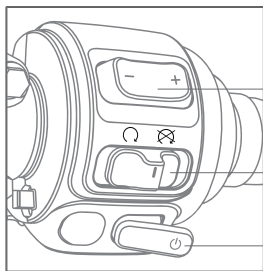

△ Right Combination Switch

① Mode Selector

② Emergency Kill Switch

③ Start/Stop Button

- ① Mode Selector: Press right part to switch up the mode. Press left part to switch down the mode.

Switch down



Switch up

- ② Emergency Kill Switch: Push the switch left to turn on the Scooter On; push the switch right to turn it off.

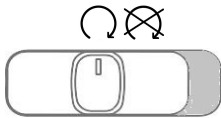

Turn on the Scooter

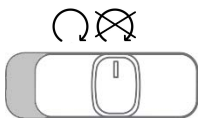

Turn off the Scooter

- ③ Start/Stop Button: **Press and hold the button for 2 seconds while holding the brake lever** in to set the scooter in the riding mode. The **READY** indicator on the dashboard will light up and you are ready to drive. Press the button again to turn off the scooter.



Operation Guide

△ Start the Scooter

- ① Press the Unlock button of the remote controller. After the Turn Signal Indicators flash twice, the scooter is unlocked.
- ② After the scooter is unlocked, insert the key into the Keyhole and turn clockwise to  position.
- ③ After system diagnostic, hold the brake and press the Start Button for 2 seconds.
- ④ The **READY** indicator will light up. Release the brake and the scooter will be ready to go.

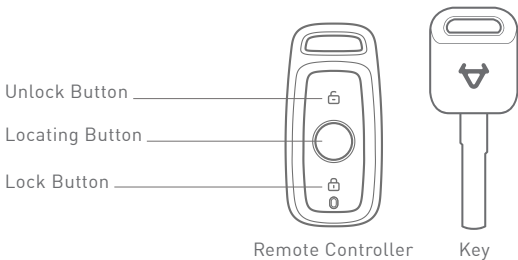

△ **Locking Steering Handlebar**

Turn the steering handlebar fully to the left, then push the key inward and turn it counterclockwise to LOCK position.

△ **Locking with Remote Controller**

The scooter can only be locked when the scooter is turned off. Press the Lock Button on the Remote Controller within an effective distance to turn on the Alarm. The Turn Signal Indicators will stay on for 2 seconds after the scooter is properly locked.

△ **Locating**

Press the Locating Button and the Turn Signal Indicators will flash for 10 seconds. If no further operation during this period, the Alarm will be on for 10 seconds. The Alarm can be cancelled by pressing the Unlock or Lock Button.

Battery Use and Maintenance Guide

△ Battery Use Conditions

- ① In order to prevent possible leakage, overheat, smoking, fire or explosion, please follow these instructions:
- ② Battery should be used at temperatures between 15°F to 110°F.
- ③ Do not expose battery to water, beverages or corrosive liquids.
- ④ Keep battery away from heat sources, open fire, flammable and explosive gases and liquids.
- ⑤ Please keep metal parts away from the battery compartment.

In the event you experience an undesirable odor, overheating or deformation of the battery, please stop using the battery immediately, keep away from the battery and contact your dealer.

Warning: The battery is not a user-repairable part. In the event of battery fault, please contact your dealer. Users dismantling the battery may lead to leakage, overheat, smoking, fire or explosion. This will invalidate any warranty.

△ **Battery Charging Conditions**

Battery should be charged at temperatures between 15°F to 95°F.

Battery charging time should not exceed 24 hours, or it will shorten the battery life. Do not charge the battery outdoors.

Attention: Do not charge the battery below 32°F.

Warning: Using non-original battery chargers may lead to leakage, overheat, smoking, fire or explosion.

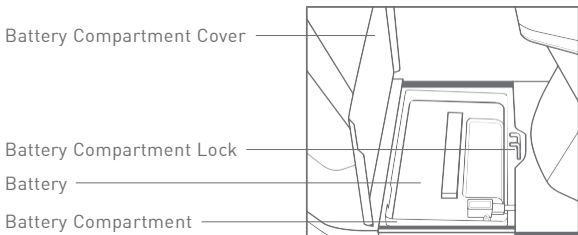

Battery Use and Maintenance Guide

△ Battery charging instructions

N-GT provides you with two modes of vehicle charging and external charging:

△ Vehicle charging mode

You can connect the charger to the vehicle charging interface at the rear of the saddle box to charge two N-GT batteries at the same time. Also the charger can be connected to the single battery of the vehicle to charge; Then the charging indicator of the N-GT meter will light up and the charging progress will be displayed.

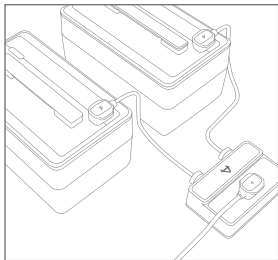
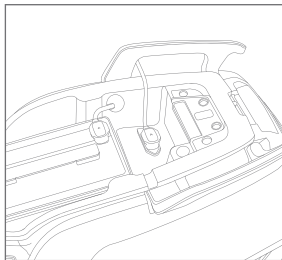

△ **External charging mode**

Remove the N-GT batteries, connect the charger separately and charge batteries externally; or use the double-battery charging adapter box to charge two N-GT batteries simultaneously. The battery indicator will light up during the charging and the charging process will be displayed.

- △ When only one battery powers the vehicle, the maximum speed is limited and the vehicle will operate in driving mode 2 - Adaptive.

△ **Battery indicator light instructions**

- ① When charging the current battery power will be displayed. After the battery is fully charged, all the indicators are always on and no longer flash.
- ② When in the non-charging state, press the power show button and the indicator will show the battery power level in the normal state.

- △ If the battery state-of-charge is less than 20%, an indicator will flash three times to remind you to charge.
- △ If all the indicators lash, it means that the battery is in a state of fault.
- △ Please call your dealer for consultation.



Warning:

- △ All operation should be strictly follow instructions in the user manual. If not, any negative result will be assumed by user.
- △ Must use original battery charger.
- △ Pay attention to the type of battery and applied voltage. Using batteries not specified for this model is forbidden.
- △ Charging should occur in a ventilated environment. DO NOT charge in closed space or under high temperature. DO NOT put charger transformer into trunk or top case while charging.
- △ While charging, connect battery with charger before connecting with an electric supply outlet. After fully charged, disconnect the electric supply before unplugging the battery plug.
- △ When the green light turns on, disconnect the power source.
- △ Avoid leaving the charger plugged into an electrical source when not charging a battery.
- △ While charging, if the signal light is abnormal, has odor, or the charger is extremely hot, please stop charging immediately and check or change the charger quickly.
- △ When using and storing the charger, please avoid foreign material such as water or other liquids to prevent an internal short circuit.
- △ DO NOT bring charger with scooter if possible, if you must, please make sure to protect charger with cushioned material.
- △ DO NOT disassemble or change the parts on the charger.

Attention:

- △ If the battery cannot be fully charged after 12 hours of charging, please stop charging the battery and contact your dealer.
- △ To maximize battery life, please keep the battery state-of-charge percentage within 20% to 80%.
- △ The battery will lose more capacity in lower temperature conditions. To be more specific, the usable capacity at 15°F is 70%, 85% at 32°F, and 100% at 75°F.
- △ The best battery capacity performance for storage is 50%. Storing battery with less than 10% or more than 90% over a long period of time will cause irreversible capacity loss to the battery.
- △ **The battery must be removed from the scooter for storage longer than one week.** While in storage, please keep the battery at a temperature of 32°F to 68°F with a state-of-charge between 30%-70%. It's advised to have at least one cycle of charge and discharge every 2 months to minimize battery capacity loss during storage.
- △ **If the battery fails due to misuse or lack of proper maintenance as instructed, any implied warranty will be void.**
- △ External Impacts may cause internal damage to the battery and may cause leakage, overheat, smoking, fire or explosion.

DOs and DON'Ts while Riding

Pre-Ride Inspection

△ Before Each Ride: Please perform the following inspection.

| Check Point | Description |
|--------------------|--|
| Steering Handlebar | 1) Steadiness. Handlebar is not loose or pivoting. 2) Steering flexibility from left to right. 3) No axial displacement or free-play |
| Braking | 1) Brake levers have 5 to 9mm travel free-play. |
| Tyres | 1) The cold inflation pressure of the front tyre is 30 psi; the cold inflation pressure of the rear tyre is 30 psi. 2) Inspect for proper tyre tread depth 3) No cracks or cuts in the tyre. |
| Battery | Adequate charge for planned travel distance. |
| Lights | Check all the lights—High Beam, Low Beam, Brake Light, Turn Signal Indicator, etc. |
| Horn | Check whether the horn is functional. |

DOs and DON'Ts while Riding

△ Braking Precautions

Maneuver the scooter upright before applying brakes. If the tyres lock and the scooter loses steering ability due to excessive braking force, loosen grip on the brake lever and the tyres will unlock helping the scooter to stabilize. Try to maintain a 1:1 ratio of front to rear braking force on slippery roads.

Caution:

For your safety, do not exceed the speed limit, use the brakes gently to maintain a safe speed while riding downhill.

Attention:

Inexperienced riders tend to use the rear brake only. This will accelerate the wear of the brake resulting in a longer braking distance.

Warning:

Using the front brake or rear brake only is dangerous because of possible loss of grip or control of the scooter. Pay extra attention and use the brakes gently when riding on dams, and around corners. Misuse of the brakes can expose the rider to great danger.

Maintenance and Repair

Users are advised to have the scooter checked and maintained on a regular basis. Scooters that have not been used for a long time should be thoroughly inspected.

△ **Regular Maintenance**

Users are advised to have their scooters inspected 3 months after purchase or within 500 miles of travelled distance. Overall inspection and maintenance is advised to be conducted every 6 months or 1750mi thereafter.

△ **Daily Maintenance**

If any problem is identified during inspection, please ensure the scooter is properly checked and maintained by a qualified technician to ensure the problem is adequately resolved.

△ **Scooter Washing**

Always remove the battery before washing the scooter. Please use mild detergent and water to wash the scooter. Use soft cloth to wipe the scooter after washing to prevent scratching.

Attention:

If the scooter is frequently used in overload, high-speed, bumpy or up/downhill riding conditions, the maintenance cycle should be shortened.

For improved quality and longer service life, please use original parts which are designed specifically for this vehicle.

Warning:

If safe and appropriate self-repair or adjustment is not possible, the scooter must be transported to an authorized dealer for maintenance and adjustment. Always choose a smooth surface and use the center-stand for any repairs or adjustments. If it is necessary to repair the scooter during a ride, park the scooter at a safe distance from all traffic.

Warning:

Do not use pressure washer to wash the scooter, especially around the battery compartment. Do not flush water near the rear inner mudguard, where the charger, controller and other parts are installed. If the charging port on the scooter is wet, do not charge before the charger dries completely. Contacting your dealer is recommended if water damage occurs.

Maintenance and Repair

△ Short-term Storage:

- ① Keep the scooter in flat, steady, well-ventilated and dry area.
- ② Charge the battery to 50% capacity prior to storage to maximize battery life.
- ③ Avoid exposure to direct sunlight and rain to reduce weather damage and aging.

△ Long-term Storage:

- ① Remember to charge and discharge battery at least every 2 months and to charge the battery to 50% capacity prior to storage to maximize battery life.
- ② Charge the battery to 100% capacity after long-term storage.
- ③ Check all parts carefully to make sure that there is no problem before riding a scooter that is being returned from a storage condition. If there is any problem, bring the scooter to your dealer for maintenance or repair.

Warning: Please disconnect the battery from the scooter during storage.

| Regular Maintenance Checklist | |
|--------------------------------------|---------------------|
| Regular Safety and Performance Check | Brakes |
| | Lights |
| | Horn |
| | Electric Parts |
| | Tyres |
| Structural Check | Lubrication |
| | Wheel Bearing |
| | Vibration Damper |
| | Central Stand |
| | Steering Bearing |
| Major Parts | Battery |
| | Main Wiring Harness |
| | Control System |

| Troubleshooting List | | |
|---|---|---|
| Malfunction Description | Causes | Troubleshooting |
| No output when powered on | <ol style="list-style-type: none"> 1. Battery disconnect 2. Dead battery 3. Alarm failure | <ol style="list-style-type: none"> 1. Connect the battery. 2. Charge the battery. 3. Contact your dealer for inspection. |
| Motor failure when turning the twist grip after vehicle is powered on | <ol style="list-style-type: none"> 1. Battery level is low 2. The motor power is interrupted when brake lever is on. 3. The Parking Mode has not been turned off yet | <ol style="list-style-type: none"> 1. Charge the battery. 2. Do not pull the brake lever and apply throttle simultaneously. 3. Check "Start the Scooter" section of this Manual. |
| Battery charge failure | <ol style="list-style-type: none"> 1. The plug of the battery is not properly connected with the battery socket 2. Battery is overdischarged | <ol style="list-style-type: none"> 1. Check whether the plug is loose. 2. Contact your dealer for inspection. |

| Troubleshooting List | | |
|--------------------------------|---|--|
| Malfunction Description | Causes | Troubleshooting |
| Dropping speed or range | <ol style="list-style-type: none"> 1. Low battery level 2. Under-inflation of tyres 3. Frequent braking and overload 4. Battery aging or normal capacity loss 5. Low battery capacity resulting from low temperature | <ol style="list-style-type: none"> 1. Charge the battery. 2. Check the tyre inflation pressure. 3. Develop good riding habits. 4. Replace the battery. 5. Normal situation. |
| Sudden stop during a ride | Dead battery | Charge the battery. |
| | Identify the fault causes in reference to the Diagnostic Codes on Dashboard. Contact your dealer if the troubleshooting methods listed in this manual is not working. | |

| Troubleshooting List | | |
|--------------------------------|--|--|
| Malfunction Description | Causes | Troubleshooting |
| 00 displayed | Communication failure or Dashboard failure | <ol style="list-style-type: none"> 1. Disconnect the battery and reconnect it after 30 seconds. 2. Check whether the wires are loosened. 3. Contact your dealer for inspection. |
| 10 displayed | FOC Controller locked rotor | Stop the scooter and restart later. |
| 11 displayed | FOC Controller under-voltage/ over-voltage | Stop the scooter and restart later. |
| 12 displayed | FOC Controller overcurrent | Contact your dealer for inspection. |
| 13 displayed | FOC Controller over-temperature | Disconnect the battery and cool it down before reuse. |
| 20 displayed | Motor over-temperature | Stop the scooter and restart when cooled down. |

| Troubleshooting List | | |
|--------------------------------|---------------------------------|--|
| Malfunction Description | Causes | Troubleshooting |
| 30 displayed | Battery overcharged | Turn on the headlight and hazard light to discharge until the code disappears. |
| 31 displayed | Charging overcurrent | Stop charging the battery and check if the charger is failed. |
| 32 displayed | Charging at low temperature | Take the battery indoor until back to normal operating temperature. |
| 60 displayed | SIM card identification failure | Contact your dealer for inspection. |
| 62 displayed | GPS module failure | |
| 63 displayed | GPS antenna short circuit | |
| 64 displayed | GPS antenna open circuit | |
| 65 displayed | ECU SN missing/incorrect | |

| Troubleshooting List | | |
|--------------------------------|--|---|
| Malfunction Description | Causes | Troubleshooting |
| 67 displayed | SIM card unpaid/ inactivated/low signal strength | Contact your dealer for inspection. |
| 99 displayed | Electronic components communication failure | Contact your dealer for inspection. |
| 110 displayed | FOC Controller failure | Contact your dealer for inspection. |
| 111 displayed | 1. The scooter is locked 2. FOC Controller verification failure | 1. Press unlock button on the Remote. 2. Contact your dealer for inspection. |
| 120 displayed | Motor failure | Contact your dealer for inspection. |
| 130 displayed | Battery over-discharged | Charge the battery. |
| 131 displayed | Over-current discharging | Stop the scooter and restart later. |

| Troubleshooting List | | |
|--------------------------------|---|---|
| Malfunction Description | Causes | Troubleshooting |
| 132 displayed | Battery over-temperature | Stop riding and let battery cool down. |
| 133 displayed | Battery under-temperature | Charge the battery after it reaches the operating temperature range. |
| 140 displayed | Twist grip failure | Please check the wires of the twist grip or contact your dealer for inspection. |
| 161 displayed | The scooter is locked by remote command | Contact your dealer for inspection. |
| 190 displayed | Controller communication failure | Contact your dealer for professional checks. |
| 191 displayed | BMS communication failure | Contact your dealer for professional checks. |

Technical Parameters

| Key Features | | | |
|-------------------|--------|------------------------|---|
| Product Weight | 240lbs | Gradeability | Dynamic: 15° |
| Rated Voltage | 60V | Maximum Designed Speed | Mode E-SAVE: 12 mph Mode DYNAMIC: 30 mph Mode SPORT: 45 mph |
| Maximum Load | 571lbs | Braking Distance | ≤15ft (18 mph) |
| Designed Capacity | | 2 Persons | |

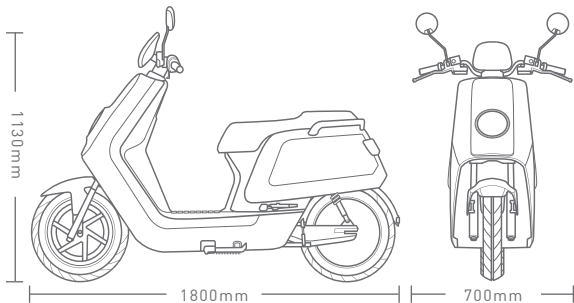

Technical Parameters

| Frame | |
|---------------------------|--|
| Front Damper | Oil Damping Direct Acting Shock Absorber |
| Rear Damper | Oil Damping Direct Acting Shock Absorber |
| Front Tyre Specifications | 90/90-12 Rim: 2.15x12 |
| Rear Tyre Specifications | 120/70-12 Rim: 3.50x12 |
| Brake system | Combination Braking System |
| Minimum Ground Clearance | 145mm |
| Seat Height | 740mm |

| Battery System | |
|-----------------------------|--------|
| Voltage | 60V |
| Capacity | 35Ah*2 |
| Standard Charging Current | 5A*2 |
| Maximum Discharging Current | 35A*2 |

| Power System | |
|-----------------------------|------------------------------|
| Motor | Tailored Motor by Bosch GmbH |
| Motor Control Mode | FOC Vector Control |
| Max. Motor Continuous Power | 3500W |
| Controller Maximum Current | 70A |

| Electrical System | |
|--------------------------|---------|
| Headlight | 12V LED |
| Turn Indicator | 12V LED |
| Taillight | 12V LED |
| Brake Light | 12V LED |
| Meter Panel | 12V LCD |
| Central Control Unit | 12V |
| USB Charging | 5V/1A |

Maintenance Record

| Date | | Mileage | |
|--------|--|---------|--|
| Notes | | | |
| Dealer | | | |

Maintenance Record

| Date | | Mileage | |
|--------|--|---------|--|
| Notes | | | |
| Dealer | | | |

Maintenance Record

| Date | | Mileage | |
|--------|--|---------|--|
| Notes | | | |
| Dealer | | | |

Maintenance Record

| Date | | Mileage | |
|--------|--|---------|--|
| Notes | | | |
| Dealer | | | |

Maintenance Record

| Date | | Mileage | |
|--------|--|---------|--|
| Notes | | | |
| Dealer | | | |

Maintenance Record

| Date | | Mileage | |
|--------|--|---------|--|
| Notes | | | |
| Dealer | | | |

Maintenance Record

| Date | | Mileage | |
|--------|--|---------|--|
| Notes | | | |
| Dealer | | | |

Battery Recycling

All batteries must be recycled after their useful life.

Batteries should be taken to a household hazardous waste disposal facility, a universal waste handler, or an authorized recycling facility. Batteries are considered hazardous waste because of the metals and/or other toxic or corrosive materials contained within.

Improper disposal of batteries may be a violation of federal, state or local laws.

Consult with your dealer for the proper methods and locations for battery recycling.

Reporting Safety Defects

If you believe that your vehicle has a defect which could cause a crash or could cause injury or death, you should immediately inform the National Highway Traffic Safety Administration (NHTSA) in addition to notifying NIU.

If NHTSA receives similar complaints, it may open an investigation, and if it finds that a safety defect exists in a group of vehicles, it may order a recall and remedy campaign. However, NHTSA cannot become involved in individual problems between you, your dealer, or NIU. To contact NHTSA, you may call the Vehicle Safety Hotline toll-free at 1-888-327-4236 (TTY: 1-800-424-9153);

go to <http://www.safercar.gov>; or write to:
Administrator, NHTSA, 400 Seventh Street, SW.,
Washington, DC 20590.

You can also obtain other information about motor vehicle safety from <http://www.safercar.gov>.

