

**///GENUINE**

**CHASE**

---

Owner's Manual

## Notice

This owner's manual contains important safety, operational and maintenance information. Any person operating this scooter should carefully read and fully understand the entire contents of the owner's manual prior to riding the scooter. If you are a parent or guardian, you are responsible for the activities and safety of your children. The Chase E-Scooter is not designed for use by children.

If you have any questions, please ask your customer service representative for assistance.

This manual contains many NOTICE, WARNING and CAUTION statements concerning the safe operation and potential consequences if safe setup, operation and maintenance are not performed. The notes, warnings and cautions contained within the manual and marked by this triangular Caution Symbol should also be given special care. For your safety, follow all safety warnings contained within the owner's manual and the labels applied to your scooter.



### WARNING

**Lithium-Ion Batteries and/or products that contain Lithium-Ion Batteries can expose you to chemicals including cobalt, lithium, nickel oxide, and nickel, which are known to the State of California to cause cancer and birth defects or other reproductive harm.  
For more information go to [www. P65Warnings.ca.gov](http://www.P65Warnings.ca.gov).**

## Introduction

Your scooter can provide many years of riding enjoyment. You must take responsibility for your own safety and the safety of others. There are many steps you can take to protect yourself and others while riding. Following operational guidelines within this manual and wearing proper safety apparel are two ways to begin cultivating safe riding habits.

Because it is impossible to anticipate every situation or condition which can occur while riding, this manual makes no representations about the safe use of scooters under all conditions. There are risks associated with the use of any scooter which cannot be predicted or avoided, and which are the sole responsibility of the rider. You should keep this manual, along with any other documents that were included with your scooter, for future reference, however all content in this manual is subject to change or withdrawal without notice. Visit <https://www.genuinescooters.com/owners-manuals/> to download the latest version.

GENUINE makes every effort to ensure accuracy of its documentation and assumes no responsibility of liability if any errors or inaccuracies appear within.

Assembly and first adjustment of your scooter requires tools and skills and it is recommended that these actions should be performed by a trained mechanic whenever possible. For your safety, please check to ensure all parts are in good condition and adjusted properly prior to riding your scooter. Contact your customer service representative in the event you have difficulty or questions.

# Table of Contents

Notice .....	1	Operation	
Introduction .....	2	Prepare to Ride .....	17
Table of Contents .....	3	Driving .....	18
Product Specifications .....	4	Folding / Transport .....	19
Package Contents .....	5	Battery	
Assembly .....	6	Range, Safety .....	20
Layout		Charging .....	21
Overview .....	7	Troubleshooting	
Controls .....	8	Causes / Solutions .....	22, 23
Digital Display .....	9	Error Codes .....	24
Safety		App	
Instructions .....	10, 11	Legal, Operation, Settings .....	25, 26, 27
Checklist .....	12, 13	Live Data, Service .....	28, 29
Controls		Parking, Transport, Storage .....	30
Power, Lighting .....	14	Scooter Care .....	31
Mode Setting .....	15	Maintenance Schedule .....	32
Throttle, Brake .....	16	Maintenance Log .....	33
		Compliance .....	34

# Product Specifications

Model	Chase
Battery Type	Lithium-Ion
Battery Capacity	48V15.6 ah 748.8 Wh
Range	30+ Miles
Motor	48V 500W Continuous 800W Peak power brushless hub motor
Maximum Speed	20 mph (Restricted)
Tires	10 inch
Braking	Front Drum / Rear Disc
Rated Maximum Load	220 lb
Lighting	LED Headlight / Taillight / Brakelight
Front Suspension	Hydraulic Telescopic Fork
Rear Suspension	Dual Shock with Swingarm Linkage
Net Weight	48.7 lb
Dimensions - Folded	46.5 in x 20 in x 18.5 in
Dimensions - Unfolded	46.5 in x 20 in x 48.5 in
Storage Temperature	32°F ~ 95°F
Charging Temperature	50°F ~ 95°F

# Package Contents

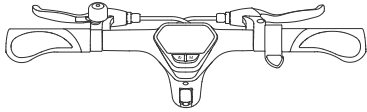

Handlebar x 1



M5 Screws x 6



Allen Wrench x 1

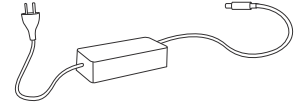

Charger x 1

## User information



User manual

User Manual x 1



Warranty

Warranty x 1

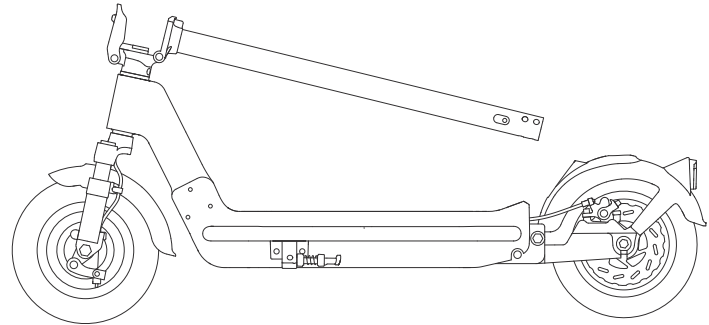

Scooter Body x 1

## Assembly

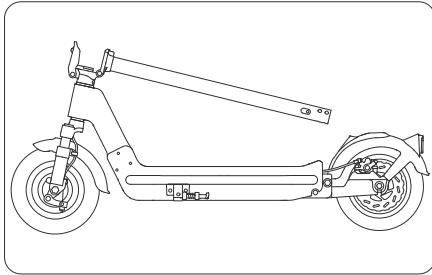

1. Remove Scooter assembly from package

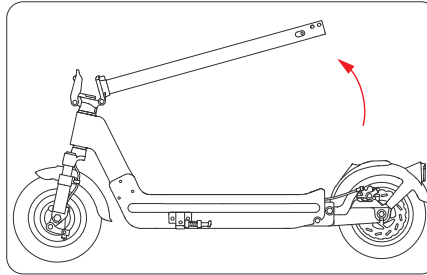

2. Raise steering stem upward until it is fully upright.

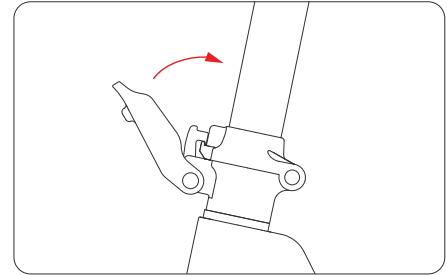

3. Rotate the quick locking lever toward the steering stem. The lock tab on the locking lever will secure the lever in place. Check stem to ensure it is securely locked and cannot fold downward.

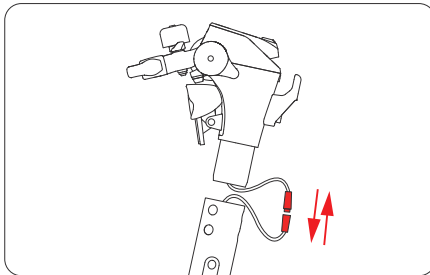

4. Connect the waterproof connector between the main scooter body and the handlebar assembly.

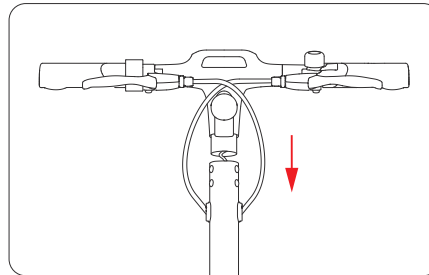

5. Insert the handlebar base into the steering stem. Ensure the handlebar orientation is correct with brake levers in front of the handlebar.

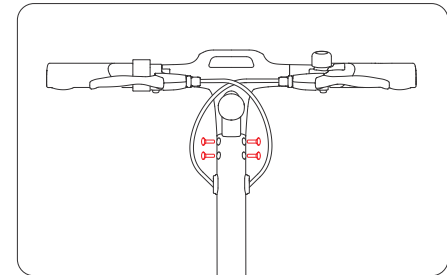

6. Locate 4 bolts and insert into steering stem. Tighten with allen wrench.

# Layout

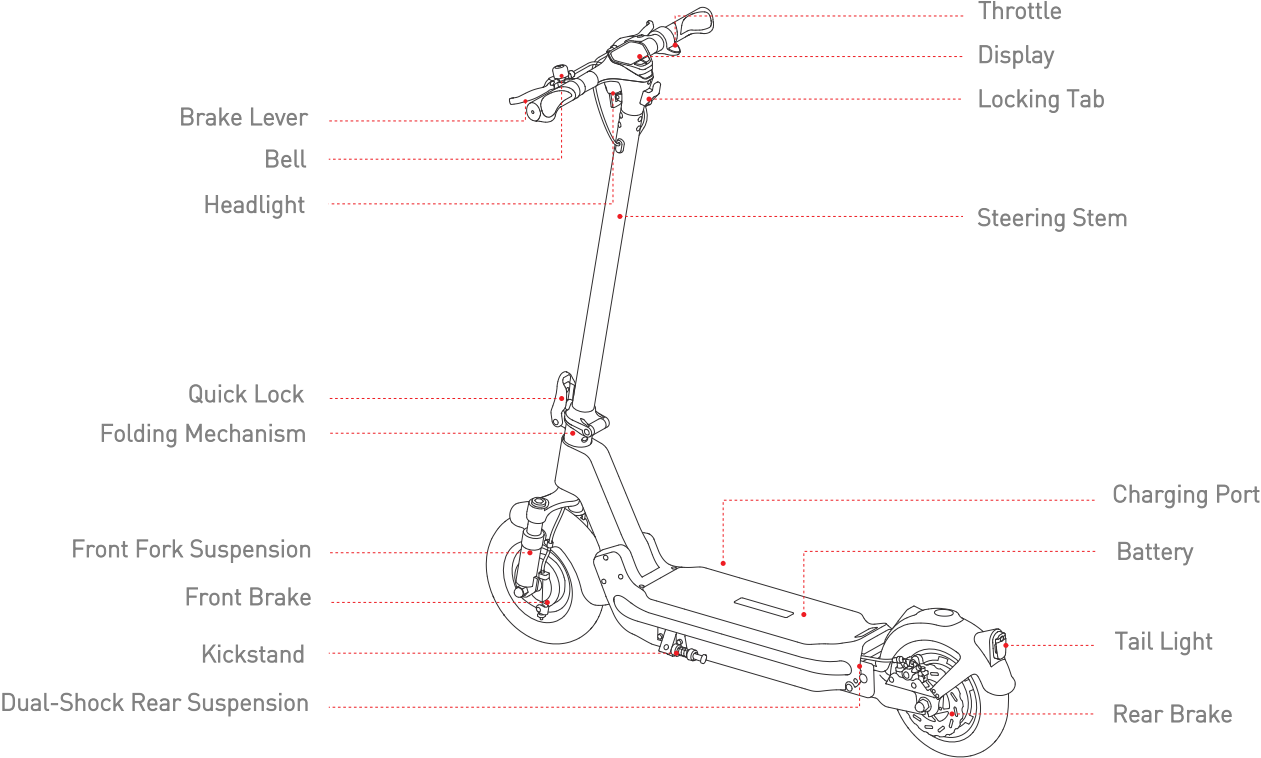



# Layout

After the scooter has been properly assembled, familiarize yourself with all controls and settings prior to operation.

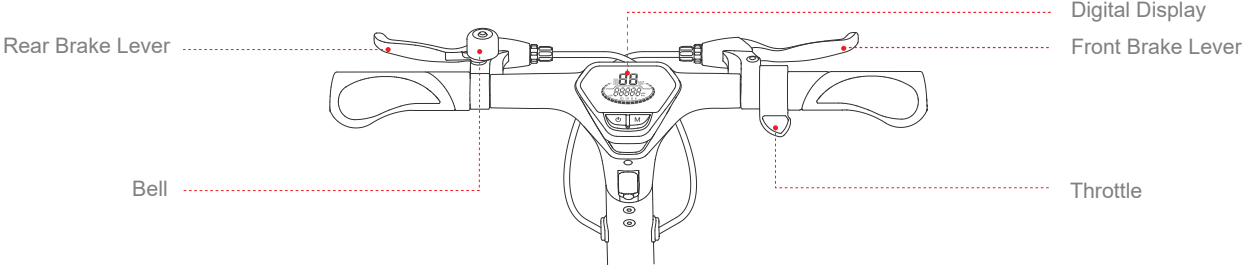

Charging Port

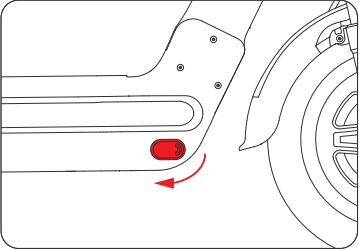

Sidestand

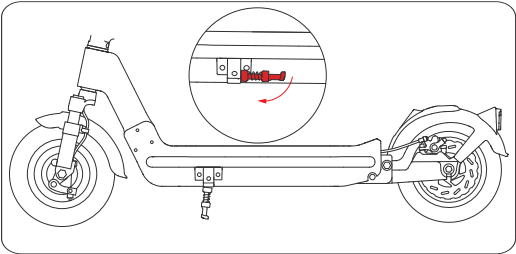

Unlock and Fold for Storage

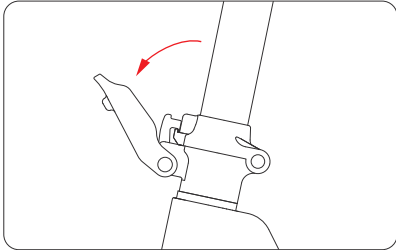

# Layout

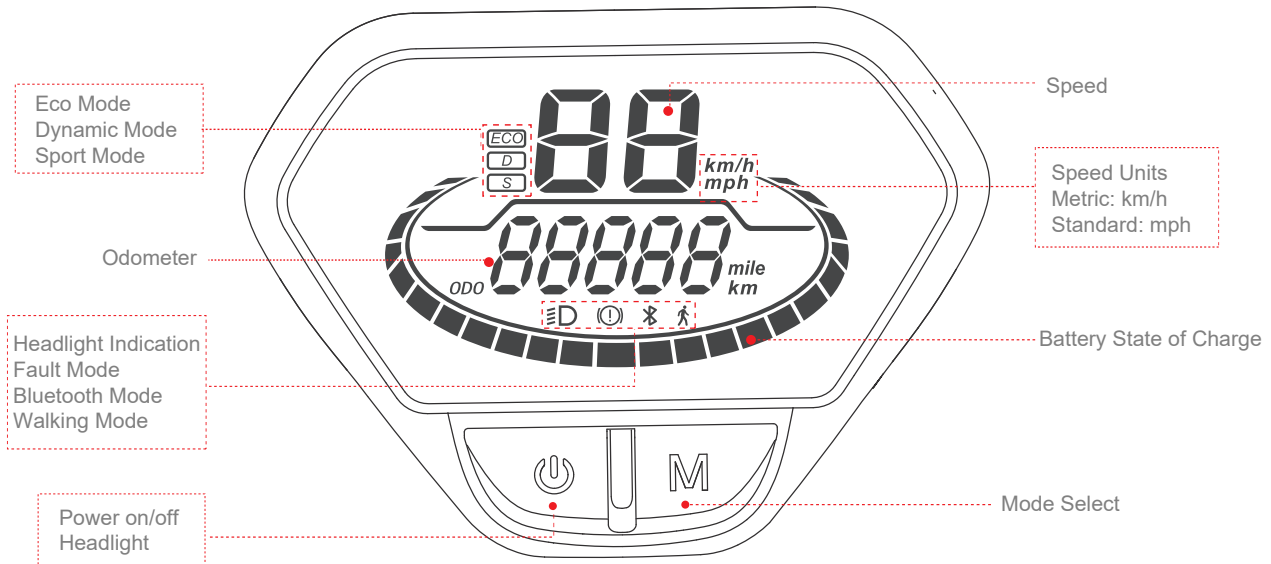

## WARNING

**Failure to familiarize yourself with vehicle settings and controls can result in serious injury or death. Make sure you understand all operational settings prior to riding your scooter.**

# Safety Instructions

There is a risk of injury or death due to loss of control, collision or a fall while riding your scooter. To reduce risk, riders must read and follow all cautions, warnings and tips in this manual. Following the safety instructions will help reduce your risk, but cannot eliminate all risk. Ride with caution, follow all laws and regulations, and be aware of your surroundings and surface conditions at all times.

## Read this Manual

Read this manual in it's entirety prior to using this product. Any use of the scooter that is not in accordance with the instructions contained within could cause injury or harm. Do not allow others to use this product unless they have read the manual in it's entirety.

## Adults Only

This scooter is to be used by adults only. This scooter should not be accessible to minors. You are responsible for ensuring the scooter is not used or accessible to people under the age of 16 or people unfamiliar with its operation.

## Wear a Helmet

Rider safety begins with quality head protection. A head injury is one of the most serious injuries that can occur. Always wear a quality DOT approved helmet that is properly buckled. If the helmet does not have a face shield, wear suitable eye protection.

## Wear Protective Apparel

Choose quality eyewear, footwear, gloves, elbow pads, knee pads and other riding apparel specifically designed with protective features. Loose clothing can be unsafe when riding your scooter.

## Make Yourself Visible

Wear bright, reflective apparel to make yourself more visible. Position yourself on pathways where other people and / or riders can easily see you. Use your hand signs, bell and other methods to help others locate you and understand your intended actions. Turn on your lights even during daylight hours to become more visible.

## WARNING

**Failure to read, understand and follow these safety instructions increases the chance of serious injury or death.  
Be sure to wear wear a helmet and proper protective gear every time you ride.**

# Safety Instructions

## Keep Hands on Handlebars

Always keep both hands on the handlebars at all times. The controls are designed so you do not need to remove either hand from the handlebar to operate the scooter. Do not change scooter modes while driving as this could cause you to lose control of the scooter.

## Keep Feet on Floorboard

Always keep both both feet on the floorboard at all times while driving at speed. Dragging your feet while driving could cause you to lose control or run over your foot. Only remove your feet from the floorboard when coming to a stop or start.

## Single Passenger Only

Your scooter is designed for one person. Do not ride the scooter with more than one person as this could overload the vehicle and cause a component malfunction resulting in loss of control of the scooter.

## Scooter Loading

Your scooter has a weight limit. Do not overload the scooter. Do not hang objects from the handlebars or steering neck as this could cause the scooter to lose control.

## Know Your Limits

Ride within the boundaries of your own skill at all times. Do not ride under the influence of drugs or alcohol. Strictly observe all laws and regulations. Always adapt your riding to account for other traffic and surface conditions.

## Surface Conditions

Surface conditions can vary greatly. Your riding stability and braking power are limited by the grip of the tires on the surface of which you are riding. When encountering loose, uneven or slippery surfaces, braking distance will increase significantly, and riding stability will be reduced. Reduce speed and perform all actions in a gradual and deliberate manner to prevent accidents.

## Visibility

Reduce your speed when riding in low visibility conditions such as darkness, fog, smoke, dust, etc. Turn on your headlight in low visibility conditions to improve your sight and to help others see you.

## Inspect and Maintain Your Scooter

Regular maintenance is required to ensure your scooter is operating at it's peak ability. Failure to maintain your scooter can result in reduced performance and could cause loss of control of your scooter. Always perform a pre-ride safety inspection of your scooter.

# Safety Checklist

*NOTICE: Before every ride, it is important to carry out the following safety checks.*

Safety Check	Basic Steps
Brakes	<ul style="list-style-type: none"> <li>● Ensure front and rear brakes function properly with sufficient lever pressure.</li> <li>● Ensure brake pads are not over worn and are correctly positioned in relation to the calipers.</li> <li>● Ensure brake cables show no obvious signs of fraying or damage.</li> <li>● Ensure brake control levers are adjusted, lubricated and tightly secured to the handlebars.</li> </ul>
Wheels and Tires	<ul style="list-style-type: none"> <li>● Ensure tires are inflated to within the recommended limits displayed on the tire sidewalls.</li> <li>● Ensure tires have tread and have no BULGES OR EXCESSIVE WEAR.</li> <li>● Ensure all rims run true and have no obvious wobbles or kinks.</li> </ul>
Steering	<ul style="list-style-type: none"> <li>● Ensure handlebar and stem are correctly locked, and allow proper steering from left to right.</li> <li>● Ensure the handlebar is set correctly in relation to the forks and the direction of travel.</li> </ul>
Suspension	<ul style="list-style-type: none"> <li>● Ensure there is no damage, binding or fluid leaks from shocks and fork.</li> <li>● Ensure the Shock mounting bolts are secure and to torque specification</li> </ul>
Lighting	<ul style="list-style-type: none"> <li>● Ensure the headlight is securely mounted and fully functional.</li> <li>● Ensure the taillight is functional and brake light flashes when brake is applied.</li> </ul>
Reflectors	<ul style="list-style-type: none"> <li>● Ensure the reflectors are securely mounted to the chassis</li> <li>● Ensure the reflectors are clean and free of damage</li> </ul>



## WARNING

**Failure to perform equipment safety checks increases the chance of vehicle failure which can result in serious injury or death. Be sure to check your equipment before each ride.**

## Safety Checklist

**NOTICE:** Before every ride, it is important to carry out the following safety checks.

<b>Safety Check</b>	<b>Basic Steps</b>
Motor Drive Assembly and Throttle	<ul style="list-style-type: none"><li>• Ensure hub motor is spinning smoothly and the motor bearings are in good working order.</li><li>• Ensure all power cables on the scooter are secured and undamaged.</li><li>• Make sure the motor axle bolts are secured.</li><li>• Make sure the throttle operation is smooth without sticking.</li></ul>
Battery Pack and Wiring	<ul style="list-style-type: none"><li>• Ensure battery is charged before use.</li><li>• Ensure there is no damage to wiring or battery pack.</li><li>• Ensure wiring connections are interlocked and wiring is appropriately secured to the bicycle.</li></ul>
Racks, Fenders, Accessories and Cargo.	<ul style="list-style-type: none"><li>• Ensure any fenders, accessories and cargo are securely mounted to the chassis.</li><li>• Ensure any fenders, accessories and cargo are not in contact with moving components of the bicycle such as wheels, handlebars, suspension, etc.</li></ul>



### **WARNING**

**Failure to perform equipment safety checks increases the chance of vehicle failure which can result in serious injury or death. Be sure to inspect your equipment before each ride.**



# Controls

## POWER ON / OFF

	While securely holding the handlebar, press and hold the power button (Long Press) to turn the scooter on. Once the scooter is powered on, the digital display will illuminate. With the scooter powered on, Long Press power button again to turn the scooter off.
---	---



## HEADLIGHT ON / OFF

	With the scooter powered on, quickly press the power button (Short Press) to turn the headlight on. When the headlight is on, the headlight icon on the dash will illuminate. Short Press power button again to turn the headlight off.	
---	---	---

## MODE SELECTION

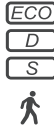
	With the scooter powered on, quickly press the mode button (Short Press) to change between modes. There are 4 different modes available. Economy, Dynamic, and Sport modes are driving modes. Walking mode is to be used only while walking alongside the scooter.	
---	--	---

## WARNING

Power on your scooter while securely holding the handlebar. Powering on without holding the handlebar and / or leaving the power on while dismounted can cause unexpected acceleration of the scooter if the throttle is accidentally applied. This could cause injury or death.

# Controls

## ECONOMY MODE

<b>M</b>	<b>Press</b> the Mode button until the "ECO" icon illuminates. The scooter will enter "Economy" mode. Economy mode will offer you the greatest range per charge at the expense of a lower top speed. Press the throttle down while in Economy mode to ride the scooter at low speed.	
----------	--	---

## DYNAMIC MODE

<b>M</b>	<b>Press</b> the Mode button until the "D" icon illuminates. The scooter will enter "Dynamic" mode. Dynamic mode will offer you an average range per charge at a medium level of speed. Press the throttle down while in Dynamic mode to ride the scooter at medium speed.	
----------	--	---

## SPORT MODE

<b>M</b>	<b>Press</b> the Mode button until the "S" icon illuminates. The scooter will enter "Sport" mode. Sport mode will offer you the highest top speed at the expense of lower range. Press the throttle down while in Sport mode to ride the scooter at maximum speed.	
----------	--	---

## WALKING MODE

<b>M</b>	<b>Press</b> the Mode button until the "Walk" icon illuminates. The scooter will enter power-assisted "Walking" mode. Press the throttle down while walking next to the scooter. The scooter will travel at a constant speed of 3 miles per hour in walking mode when the throttle is pressed.	
----------	--	---

### **WARNING**

**Select driving modes only while the scooter is stationary. Pressing the mode button while riding requires you to remove your hand from the handlebar which is unsafe. Changing modes while driving may result in abrupt acceleration which could cause you to lose control of the scooter.**



# Controls

## THROTTLE

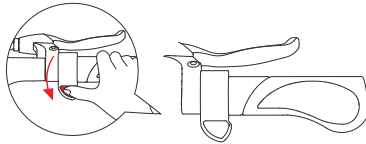

The throttle is located on the right handlebar. While securely holding the handlebar, press the throttle downward with your thumb. Once the throttle is pressed, the scooter will send power to the motor to accelerate. Releasing the throttle will cease sending power to the motor and the scooter will coast. The default setting requires the scooter to be rolling forward for the throttle to operate. The push-to-start feature can be deactivated in the app.

## CRUISE CONTROL

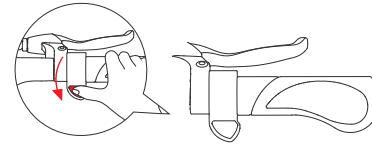

Holding the throttle fully downward for 10 seconds or more without release will place the scooter in cruise control mode. The scooter will make an audible beep once you have entered cruise control mode. In this mode, the scooter will maintain maximum speed without the need to apply the throttle. Apply the brake to deactivate cruise control. Cruise control features can be changed or deactivated in the app if so desired.

## REAR BRAKE

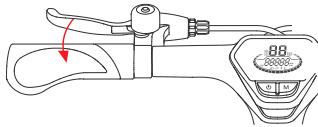

The rear brake is on the left side of the scooter. To activate the rear brake, pull the lever toward the handlebar. Once the scooter has decelerated to below 10 mph, the regenerative braking system will engage in addition to the manual brake.

## FRONT BRAKE

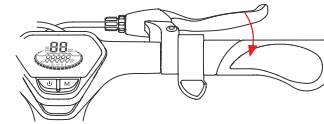

The front brake is on the right side of the scooter. To activate the front brake, pull the lever toward the handlebar. Once the scooter has decelerated to below 10 mph, the regenerative braking system will engage in addition to the manual brake.

# Operation

## 1) PREPARE TO RIDE

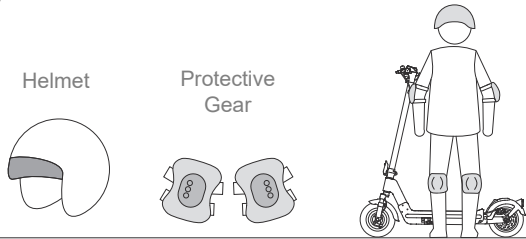

Prepare to ride your scooter by wearing proper safety gear. There is always a risk of injury in the event of a fall, so always wear safety gear every time you ride.

## 2) POWER ON

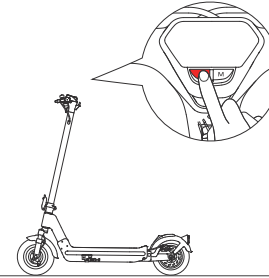

Power your scooter on by pressing the power button. Check the battery status. If the battery state of charge is too low, please charge the scooter immediately.

## 3) SELECT MODE

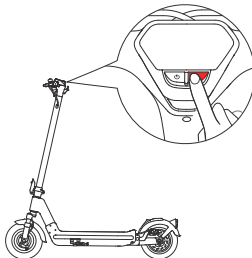

Select the driving mode you wish prior to driving the scooter. Do not change driving modes while riding the scooter as this requires you to remove your hand from the handlebar.

## 3) RAISE KICKSTAND

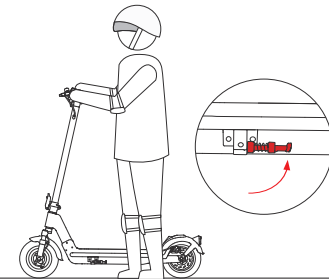

Raise the kickstand to the upright position. Prepare yourself to ride. Always keep both hands on the handlebar at all times while driving.

# Operation

## 5) START

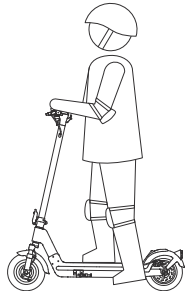

Place one foot on the floorboard, use the other foot to push the scooter forward and begin rolling.

## 6) ACCELERATE

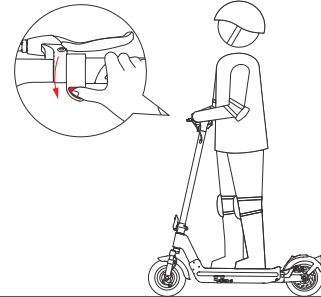

Once you are rolling, place your second foot on the floorboard and maintain your balance. Press the throttle downward gently to accelerate.

## 7) TURNING

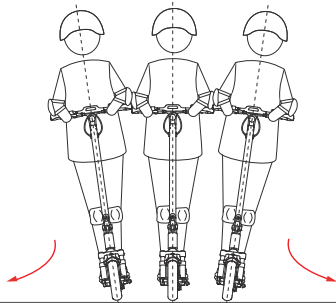

Turn by leaning your center of gravity slightly in the direction you wish to go while turning the handlebar slowly. The higher your speed, the less input is required to turn.

## 8) DECELERATION

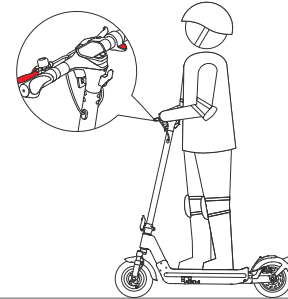

To slow down, release the throttle and apply the brakes gently. Using both brakes will slow your scooter more quickly than using one brake. As you slow, regenerative motor braking will begin.

# Operation

## 9) UNLOCK

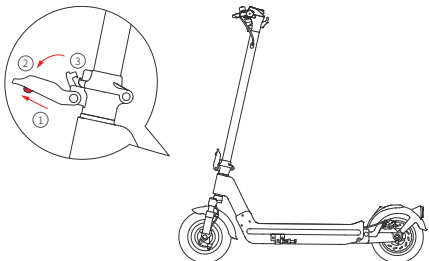

Turn off the scooter. 1) slide lock upwards. 2) Pull lever downward toward the front tire. 3) Press down on lever to fully unlatch.

## 10) FOLD

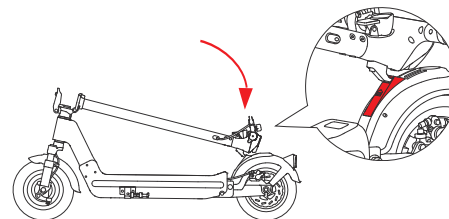

Fold the steering stem downward toward the rear fender. Press on the arrow located on the rear fender to latch.

## 11) TRANSPORT

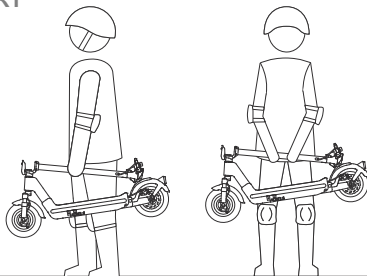

Once stem is securely latched, hold stem for transport.

## 12) UNFOLD

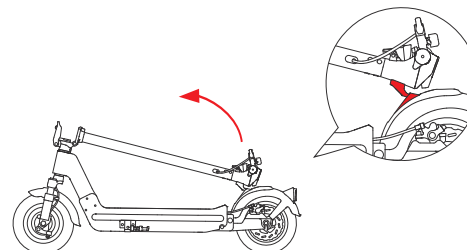

Press arrow on rear fender to unlatch the stem from the fender. Raise stem and locking lever until thumb lock is secure in the fully upright position.

# Battery

## BATTERY CAPACITY INDICATION

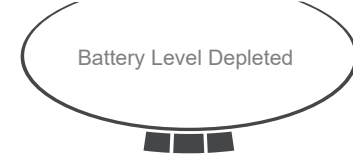

The digital display features a battery capacity gauge. It is recommended that users charge the battery as soon as possible once there are few bars remaining on the display. Once the battery is fully depleted, the last remaining bar will begin to flash communicating to the user that they should cease power assisted operation immediately and charge the battery as soon as possible.

## BATTERY RANGE

The battery range is the distance the scooter will travel on a single full charge of the onboard battery pack. The range will vary greatly based on usage including tire pressure, elevation change, speed, payload, acceleration, number of starts and stops, surface type, ambient air temperature and mode level selection among other factors.

We suggest that you select a lower power level when you first ride your scooter to get to know the range of your scooter along your travel routes. Once you become familiar with the range requirements of your travel routes, and the capabilities of your scooter, you can then adjust your riding characteristics if you so desire. To extend the range of your battery, avoid steep hills, as well as sudden starts and stops. Use lower mode settings whenever possible.

## BATTERY SAFETY

- The battery should be used between the temperatures of 15° and 115° F.
- Do not expose the battery terminals or submerge battery in water, beverages or corrosive liquids
- Keep the battery away from heat sources, open fire, flammable and explosive gases and liquids.
- In the event you smell an odd odor, notice overheating or deformation of the battery or external damage. Cease use immediately.
- Be careful not to damage the battery.

# Battery

## BATTERY CHARGING

To charge the battery, pull back the rubber charging port cover on the side of the scooter to expose the charging port. Follow the charging instructions below to charge the battery.

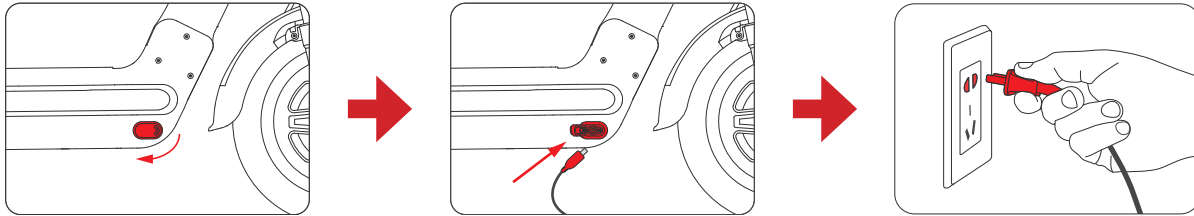

- 1) Place the charger on a flat surface in a secure location, uncovered, away from sunlight and debris.
- 2) Inspect the charger cables, charger and battery for damage before beginning each charge.
- 3) Connect the DC output plug from the charger to the charging port on the lower, right side of the frame, then plug charger into wall socket.
- 4) Observe the charging light on the DC charger. While charging, the LED light on the charger will remain red in color. During charging, the charger may become warm to the touch. Charging normally takes 6~8 hours. Once the charge cycle has completed, the LED light will turn green indicating that battery charging is completed.
- 5) Disconnect the battery from the DC charger. Replace rubber cover over charging port. Unplug the DC charger from the wall socket.

The battery must maintain a state of charge at all times. The battery should be recharged after each use. There is no memory effect, so you can charge the battery after short rides without damage. If the battery state of charge drops too low, the battery will become non-functional. Failure to maintain the battery state of charge will not be covered under any warranty that may otherwise apply.

### **WARNING**

**The battery state of charge must be maintained at all times. If the battery state of charge drops too low, the battery cannot be recharged. Do not expose battery to sources of high heat or liquids. Catastrophic failure of the battery may occur and subsequently cause injury or death.**

# Troubleshooting

SYMPTOMS	COMMON CAUSES	POSSIBLE SOLUTIONS
E-Scooter won't power on	<ol style="list-style-type: none"> <li>1. Insufficient battery power</li> <li>2. Faulty connections</li> <li>3. Battery not fully seated in tray</li> <li>4. Improper power on sequence</li> <li>5. Brakes are applied</li> </ol>	<ol style="list-style-type: none"> <li>1. Charge the battery pack</li> <li>2. Clean and repair connectors</li> <li>3. Install battery correctly</li> <li>4. Power on bike using proper sequence</li> <li>5. Disengage brakes, check brake switch</li> </ol>
Irregular acceleration and /or reduced top speed	<ol style="list-style-type: none"> <li>1. Insufficient battery power</li> <li>2. Loose or damaged throttle</li> </ol>	<ol style="list-style-type: none"> <li>1. Charge or replace battery</li> <li>2. Replace throttle</li> </ol>
Scooter is powered on, but the motor does not respond to throttle	<ol style="list-style-type: none"> <li>1. Scooter is in lock mode.</li> <li>2. Scooter is in push-to-start Mode</li> <li>3. Loose wiring</li> <li>4. Loose or damaged throttle</li> <li>5. Loose or damaged motor plug wire</li> <li>6. Damaged motor</li> </ol>	<ol style="list-style-type: none"> <li>1. Use app to unlock the scooter.</li> <li>2. Ensure scooter is rolling forward. Press throttle.</li> <li>3. Repair and or reconnect</li> <li>4. Tighten or replace</li> <li>5. Secure or replace</li> <li>6. Repair or replace</li> </ol>
Reduced range	<ol style="list-style-type: none"> <li>1. Low tire pressure</li> <li>2. Low or faulty battery</li> <li>3. Driving with too many hills, headwind, braking, and/or excessive load</li> <li>4. Battery discharged for long period of time without regular charges, aged or damaged</li> <li>5. Brake drag</li> </ol>	<ol style="list-style-type: none"> <li>1. Adjust tire pressure</li> <li>2. Check connections or charge battery</li> <li>3. Assist by using pedals or adjust route</li> <li>4. Replace the battery</li> <li>5. Adjust, repair or replace cable, pad, rotor</li> </ol>
The battery won't charge	<ol style="list-style-type: none"> <li>1. Charger not well connected</li> <li>2. Charger damaged</li> <li>3. Battery damaged</li> <li>4. Wiring damaged</li> </ol>	<ol style="list-style-type: none"> <li>1. Adjust the connections</li> <li>2. Replace</li> <li>3. Replace</li> <li>4. Repair or replace</li> </ol>

# Troubleshooting

SYMPTOMS	COMMON CAUSES	POSSIBLE SOLUTIONS
Brake power diminished	<ol style="list-style-type: none"> <li>1. Brake pads worn</li> <li>2. Cable stretched</li> <li>3. Brake rotor worn or warped</li> <li>4. Brake overheating</li> </ol>	<ol style="list-style-type: none"> <li>1. Replace the brake pads</li> <li>2. Inspect free play, adjust or replace</li> <li>3. Replace the brake rotor</li> <li>4. Check for brake drag. Adjust brakes.</li> </ol>
Irregular ride quality	<ol style="list-style-type: none"> <li>1. Fork and/or shock adjustment</li> <li>2. Insufficient suspension fluid in fork or shock</li> <li>3. Tires or Tube Issue</li> </ol>	<ol style="list-style-type: none"> <li>1. Adjust preload, rebound settings</li> <li>2. Repair or replace shocks or fork</li> <li>3. Check tires / tube for surface irregularities. Check tire pressure.</li> </ol>
Wheel or motor makes strange noises	<ol style="list-style-type: none"> <li>1. Damaged motor bearings</li> <li>2. Damaged wheel rim</li> <li>3. Damaged motor wiring</li> </ol>	<ol style="list-style-type: none"> <li>1. Replace</li> <li>2. Repair or replace</li> <li>3. Repair or replace motor</li> </ol>



## Troubleshooting

Error Code	Description	Solutions
E04	Short circuit faulty	Check if there is a short circuit in the wiring or installation. Fix short circuit or replace the controller to eliminate the issue.
E10	Dashboard communication failure	First, check whether the connection line between the instrument panel and the controller assembly is working normally or not. Shut down and restart the scooter. Then re-plug in the assembly line interface. If the error has not disappeared, then the instrument or controller needs to be replaced to eliminate the error.
E11	Motor current sensor error	Check the phase line of the controller or motor. If the phase line is working properly, then the controller needs to be replaced to eliminate the error.
E14	Throttle hall (voltage sensor) error	Check whether the throttle is reset to zero and whether the throttle cable and throttle are functioning normally or not. You can unplug the throttle cable and restart the scooter to troubleshoot the problem.
E15	Brake Hall (voltage sensor) error	Check whether the brake is reset to the zero position or not. Also check the brake line to see if it is functioning normally or not. To eliminate the problem, unplug the electronic brake wiring and restart the scooter.
E16	Motor Hall (voltage sensor) error	Check that the motor hall wiring is functioning normally or not. If the error occurs when braking, the motor or the controller needs to be replaced to eliminate the problem.
E21	BMS Communication error	Check the display to make sure that it is functioning properly. If there is an issue, please replace display. If the issue is not with the display, please check the functionality of the controller. If the controller is no working properly, please replace the controller.
E50	Battery high voltage	Check whether the battery voltage is normal or if there is a cycling failure. To eliminate the problem, replace the battery or controller.
E53	System Overload Error	To correct the issue, exceed the system overload and restart the scooter. If the error code still shows after restart, the controller needs to be replaced to eliminate the problem.
E55	Controller high temperature alarm	The temperature of the controller is too high and the vehicle needs to be restarted after the vehicle is cooled. If there is a BOOT failure, then to eliminate the program, the controller needs to be replaced.
E56	Low voltage alarm	Insufficient power, please charge!

When an error code is displayed, promptly perform any necessary repairs. After a fault occurs, the e-scooter will not function normally. It is highly suggested to take your e-scooter to a qualified technical for diagnostics and repair.

# Parking, Transport and Storage

Please follow these basic parking, storage and transport tips to ensure your bike is well cared for on and off the road.

## **PARKING**

- Park in a flat, steady, well-ventilated and dry area if available. It is recommended to park indoors whenever possible.
- Remove the key from the bike and ensure the battery is locked to the frame or removed and brought with you for security.
- Avoid exposure to direct sunlight and rain to reduce potential damage and aging. If you must park outdoors in rain, or wet conditions, you should only leave your E- Scooter outside for a few hours and proceed to park the scooter in a dry location afterwards to allow all systems to dry out. Use in wet conditions mandates a more regular maintenance schedule to ensure all systems are always working safely and reduce corrosion.

## **TRANSPORT**

- Before transport, make sure your scooter is turned off. Follow instructions for folding your scooter for transport.
- Handle with care. Do not throw or toss the scooter when transporting. Secure your scooter when in transit.
- Use two hands and bend your knees when lifting and moving your scooter to prevent injury

## **STORAGE**

- Store your E-Scooter indoors if at all possible. Store in a warm, dry location to reduce corrosion.
- Charge your battery periodically to ensure the battery does not fully discharge during storage period.
- Hang your E-Scooter if possible to prevent flat spots on your tires. If hanging is not possible, rotate the tires every couple of weeks.
- Lubricate the cables prior to storing to ensure corrosion does not damage components during storage period.
- Cover your E-Scooter to eliminate dirt and debris from accumulating on critical components.
- After long periods of storage, complete full safety check and perform the full maintenance schedule to place E-Scooter back in service.

# App

The Genuine App is available for Android and Apple devices. The app will give you access to additional information and features as well as offer customization to make your scooter tailored to your personal preferences.

Visit the links below or scan the QR code to the right to download.

**Apple:** <https://apps.apple.com/us/app/genuine-scooter/id6474163662>

**Android:** <https://play.google.com/store/apps/details?id=com.HB.Genuine>

Upon opening the app, you will have the option to review and agree or disagree to the Terms of Use, Privacy Policy and Derestrict Notice. (Right)

If you agree to the terms, press the "Agree" button at the bottom right of the screen and you will continue into the App Start screen. (Right) If you disagree to the terms, press the "Disagree" button at the bottom left the app will close.

Genuine does not store any user data, so you will need to agree to these terms every time you open the app. Because Genuine does not store any personal user information, you have the highest level of privacy possible while still benefiting from the advanced features available to you via the App.

Once you are on the Start screen (Far Right), power on your scooter, then press the "Start search" button at the bottom of the screen. Your phone will automatically recognize and connect with your scooter at this point. Once connected, you will hear an audible beep and you will taken to the Home screen. A device name will appear on the home screen. The device name will begin with "Robot" or "Trail" followed by a series of numbers.

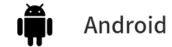

## Terms of Use, Privacy Policy and Derestrict Notice

Updated: November 20, 2023

This is an agreement between you, Scooterworks USA, LLC ("Scooterworks"), and Scooterworks USA, LLC ("Scooterworks") (collectively "we" and "us"). Please read the following Terms of Use, Privacy Policy, and Derestrict Notice, and the other applicable rules, policies, and terms available through the Device or its companion app (collectively, the "Agreement") before using the Device. By using the Device, you agree to be bound by the terms of this Agreement. If you do not accept the terms of this Agreement, then you may not use the Device and you may return it in accordance with the applicable return policy.

### TERMS OF USE

For the purpose of this Agreement:

"Device" means devices, including, but not limited to, the Genuine Chase and the Genuine Trail, and, in each case, any related accessories or apps for those devices.

"Services" means our provision of Software and support and other services that we provide Device users.

"Software" means all software we make available to you for use on a Device.

#### 1. Features and Software

a. **Recreation Services.** Your Device is a recreational product. Before mastering riding skills, you need to practice. We are not responsible for injuries or damage caused by a rider's inexperience or failure to follow the instructions in all applicable owners' user manuals or tutorials. If you are using a Device for riding, you are solely responsible for driving safely, observing all traffic rules, and using your own judgment while driving and selecting routes.

b. **Use of the Software.** You may use the Software only on your Device.

#### 2. Connectivity and Availability

a. **Internet and Wireless Connectivity.** Your Device may require an Internet connection or data plan from a third party provider in order to use some features. In such cases, your Internet connection or data plan is subject to the fees, restrictions, terms, and limitations imposed by the provider.

b. **Availability.** Some Services may be unavailable, vary by device or geography, for example, be offered for a limited time, or require certain hardware configurations. In addition, if your Device receives wireless data services and is located in an area where it cannot access such services, you may not be able to use some or all of the Services or other features of your Device. We are not responsible for the unavailability of wireless data services or any corresponding loss of Services.

#### 3. Intellectual Property

a. You may use the Software to publish your original works, opinions, and views you are entitled to express, or release data, writing, information, signatures, photos, personal information, audio, video, links, and other information contents. You guarantee that ownership and all intellectual property rights of information you publish or upload are owned or legally authorized to you. If an infringement or complaint of copyright is raised by any third party, we are entitled to delete any data or content and entitled to pursue any other available resources. You shall indemnify and assume all applicable legal responsibilities to the damaged parties.

b. All original contents published by you (including, but not limited to, writings, pictures, and videos) must be owned or legally authorized to you.

c. When you use our Services or share, publish, or upload any content protected by intellectual property rights in relation to our Services, it will be deemed to be you granting us a non-exclusive, free of copyright, royalty, irrevocable, transferable, sub-licensable, and worldwide license. Under such license, we are granted to use such content in any product, Service, and promotion in any form, including, but not limited to, website, related application, or other internet products or social media software.

Disagree

Agree

# GENUINE



Start search



Preview



Website



Mail



Service

# App

**HOME** - The home screen is the default screen within the Genuine App.

The center of the home screen displays the current speed on the top half and the current state of charge on the bottom half of the circular icon.



**Device** - Press this button to reconnect to your scooter if bluetooth signal is lost.

**Service** - Press this button to enter into the service page where you can find the most current version of the User Manual, Error Code Guide, Contact information for Genuine Scooters, and the Genuine Scooters Store.

**Mode** - Indicates the current mode selected via the toggle switch on the right handlebar. This button is informational only and will not allow you to change modes on this model.

**Lock** - This is a safety / security feature. While the scooter is on, press this button to lock or unlock the scooter. When the scooter is in Lock mode, the scooter will not respond to throttle input and cannot be powered down. Unlock the scooter to enable throttle operation or to power down the scooter.

**Details** - Press this button to see detailed information on your scooter including Odometer, Temperature, Drive Time, Current, Voltage and Error Codes.

**Light** - This Icon indicates the headlight is on or off. Pressing this Icon will not change the current state of the headlight on this model.

**Settings** - Press this button to change user settings such as zero start, cruise control, imperial / standard units, maximum speed and mode memory.

# App

**SETTINGS** - The settings screen allows you to customize your scooter to your specific liking.

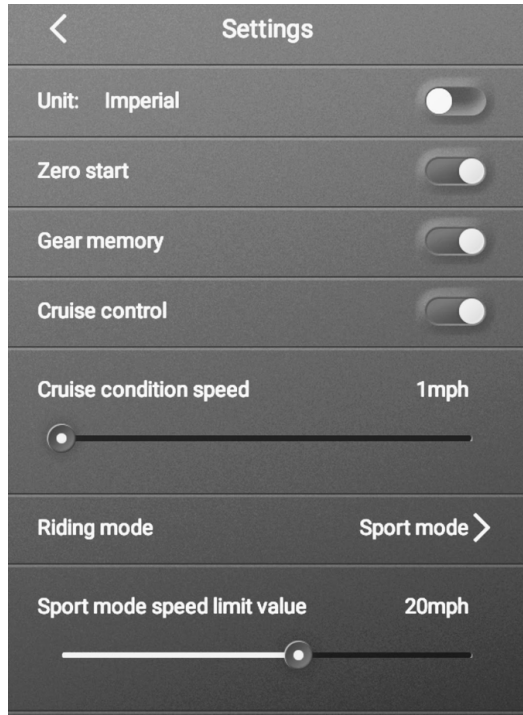

**Unit** - Toggle this switch to select between metric and imperial units

**Zero Start** - Toggle this switch to select between zero start and push-to-start. Push-to-start requires you to push the scooter forward with your foot within 2 seconds of entering "Ready" mode before the scooter will respond to input from the throttle. Enabling Zero Start allows the throttle to move the scooter even when it is stationary as long as Ready mode is enabled .

**Gear Memory** - Not used on the Trail model

**Cruise Control** - Cruise control is enabled by default at the factory. Holding the throttle down uninterrupted for 10 seconds will automatically enable the scooter cruise control. An audible beep will occur notifying you of the cruise control being enabled. The scooter will remain at a constant speed even if the throttle is released. The scooter will disable cruise control upon braking. Cruise control speed is set to a minimum conditional speed via a sliding bar.

**Riding Mode Speed Limit Value** - The maximum speed can be changed for each riding mode within a certain range of speed. Be aware that enabling your scooter to exceed speeds of 20mph in any mode makes it illegal for use in most public areas. Be aware of local, state and federal laws. Only exceed speeds of 20mph in closed course areas of operation and do so in a manner which does not subject you or others to bodily harm. Modify the maximum speed at your own risk.

# App

**DETAILS** - The details screen provides real-time information on the operating state of your scooter. Hit the back arrow to return to the main screen.

Details	
Mileage for this journey	0.0ml
Total mileage	0.5ml
Scooter temperature	16.2°C
Total driving time	0H 24M 55S
Current speed	0.0MPH
Current	-0.0A
Voltage	49.9V
Power	1.5W
Error code	0
Warning code	0
Electronic control version	82.5.1 (052000b8)
Bluetooth version	0.6.6 (0459)
App version	1.0.3
Firmware upgrade	>

**Mileage for this journey** - The mileage accumulated since the scooter was powered on.

**Total Mileage** - The total mileage accumulated since the scooter was manufactured.

**Scooter Temperature** - The current operating temperature of the scooter.

**Total Driving Time** - The cumulative operational time since the scooter was manufactured.

**Current Speed** - The current speed of the scooter.

**Current** - The current current.

**Voltage** - The current battery voltage.

**Voltage** - The current watts being consumed.

**Error Code** - Active error codes will display here.

**Warning Code** - Not used on this model.

**ECU Version** - version reference ID

**Bluetooth Version** - version reference ID

**App Version** - version reference ID

**Firmware Upgrade** - Select the arrow at right to download the latest firmware.

# App

**SERVICE** - The service screen is the home for additional information on your scooter and Genuine. Hit the back button at the top of the screen to exit.



**Manual** - Select this tab to view the Owner's manual

**Error Code** - Error Code guide

**Contact Us** - Contact information for Genuine Scooters.

**Mall** - Genuine Scooters Store.

## Scooter Care

To ensure safe riding conditions you must ensure your scooter is properly maintained. You should follow these basic guidelines and see your certified mechanic at regular intervals to ensure your scooter is safe for use.

1. Properly maintain battery by keeping it fully charged when not in use.
2. Never immerse the scooter or any components in water as the electrical system may become damaged. Do not use pressure washers, hose sprays and other sources of high volume water flow to wash your scooter.
3. Periodically check wiring and connectors to ensure there is no damage and the connectors are secure.
4. To clean, wipe the frame with a damp cloth soaked in a mild non-corrosive detergent mixture. Dry with a cloth.
5. Store your E-Scooter under shelter; avoid leaving it in the rain or exposed to corrosive materials. If exposed to rain, dry your scooter afterwards.
6. Riding on the beach or in coastal areas exposes your scooter to salt which is very corrosive. Damage from corrosion is not covered under warranty so special care should be given to your scooter when used in coastal areas or areas with salty air or water.
7. If the paint has become scratched or chipped in the metal, use touch up paint to prevent rust. Clear nail polish can also be used as a preventative measure to protect any exposed metal from surface scratches.
8. Regularly clean and lubricate all moving parts, tighten components and adjust as required per the maintenance schedule.
9. If your E-Scooter has fallen or impacted another object while parked or riding, you should consider your scooter unsafe to ride until you consult with a certified mechanic for a comprehensive inspection and repair if necessary.
10. Any aftermarket modifications to your E-Scooter could create an unsafe riding condition and/or void the warranty. Consult with a certified mechanic for any modifications you wish to make to your scooter.



# Maintenance Schedule

Perform maintenance actions as instructed per the periodic schedule shown below I - Inspect C - Clean E - Exchange L - Lubricate

Component	Action	First 100 miles	250 miles or Every 3 Months	500 miles or Every 6 Months	1000 miles or Every Year	2000 miles or Every 2 Years
General Inspection	Inspect scooter thoroughly	I	I	I		I
Controls	Inspect scooter controls for function, lubricate cables	I			I / L	I / L
Steering Bearings	Inspect steering bearings for play, lubricate	I				I / L
Electrical Wiring	Inspect electrical wires for frays / damage	I			I	
Lights	Inspect all lighting for proper function	I			I	
Wheels / Rims	Inspect wheels for damage or wobble	I			I	
Tires	Inspect tires for tire pressure / wear / damage	I	I	I	I	E
Brake Pads / Rotors	Inspect brake pads / rotors for wear, replace			I	I	E
Brake Cables	Inspect brake free play, adjust or replace.	I		I	I	E
Telescopic Fork	Inspect fork mount torque, inspect for fluid leaks	I		I	I	I
Shocks	Inspect shock mount torque, inspect for damage	I		I	I	I
Throttle	Inspect throttle operation, lubricate	I		I / L	I / L	I / L
Kickstand	Inspect mounting torque, lubricate	I / C / L	I / C / L	I / C / L	I / C / L	I / C / L
Brake Levers	Inspect for wear, remove excess debris, lubricate	I, L	I / C / L	I / C / L	I / C / L	I / C / L

## WARNING

**Failure to inspect and maintain your E-Scooter can result in a hazardous operating condition that can cause an accident which could lead to injury or death. If you are incapable of performing the maintenance as shown in the maintenance schedule, bring your E-Scooter to a qualified mechanic for service.**

# Maintenance Log

Mileage	Maintenance Performed	Date	Mileage	Maintenance Performed	Date

# Compliance

## **Federal Communications Commission (FCC) Compliance Statement for USA**

This device complies with part 15 of the FCC rules. Operation is subject to the following two conditions: (1) This device may not cause harmful interference, and (2) this device must accept any interference received, including interference that may cause undesired operation. Any Changes or modifications not expressly approved by the party responsible for compliance could void the user's authority to operate the equipment.

NOTE: This equipment has been tested and found to comply with the limits for a Class B digital device, pursuant to part 15 of the FCC Rules. These limits are designed to provide reasonable protection against harmful interference in a residential installation. This equipment generates, uses and can radiate radio frequency energy and, if not installed and used in accordance with the instructions, may cause harmful interference to radio communications. However, there is no guarantee that interference will not occur in a particular installation. If this equipment does cause harmful interference to radio or television reception, which can be determined by turning the equipment off and on, the user is encouraged to try to correct the interference by one or more of the following measures:

- Reorient or relocate the receiving antenna.
- Increase the separation between the equipment and receiver.
- Connect the equipment into an outlet on a circuit different from that to which the receiver is connected.
- Consult the dealer or an experienced radio/TV technician for help.

This equipment complies with FCC radiation exposure limits set forth for an uncontrolled environment.

Genuine is not responsible for any changes or modifications not expressly approved by Genuine. Such modifications could void the user's authority to operate the equipment.

## **All batteries must be recycled after their useful life.**

Batteries should be taken to a household hazardous waste disposal facility, a universal waste handler, or an authorized recycling facility. Batteries are considered hazardous waste because of the metals and/or other toxic or corrosive materials contained within.

## **Improper disposal of batteries may be a violation of federal, state or local laws.**

Consult with your dealer for the proper methods and locations for battery recycling.

**///GENUINE**

GENUINESCOOTERS.COM  
2700 W Grand Ave. Chicago, IL USA