

M+

USER MANUAL

This owner's manual contains important safety, operational and maintenance information. Any person operating or riding as a passenger on your scooter should carefully read and fully understand the entire contents of this manual prior to riding the vehicle. For your safety, follow all safety warnings contained within the owner's manual and the labels applied to your scooter.

If you have any questions, please ask your dealer for assistance.



WARNING California Proposition 65

Lithium-ion Batteries and/or products that contain Lithium-ion Batteries can expose you to chemicals including cobalt, lithium, nickel oxide, and nickel, which are known to the State of California to cause cancer and birth defects or other reproductive harm.

For more information go to
www.P65Warnings.ca.gov

CONTENTS

General Notice	2
Precautions	3
Safety Notice	4
Download APP and Register	6
Rapid Installation	8
Parts Info	10
Operation Guide	15
Battery Use and Maintenance	22
Pre-Ride Inspection	28
Maintenance and Repair	30
Troubleshooting List	34
Technical Parameters	41
Maintenance Record	46
Reporting Safety Defects	50
Battery Recycling	51

General Notice

- △ Please read this User Manual carefully for proper operation before riding the scooter.
- △ For your safety, please check whether all parts of the scooter are in good working condition according to this User Manual before riding. Contact your dealer immediately in the event you encounter any problems.
- △ Please obey all traffic laws.
- △ Please pay attention to deep water. It may cause corrosion or failure of the motor, battery, or other parts if water level reaches above the wheel axle.
- △ Do not dismantle the scooter on your own. Please contact your dealer for replacement or purchase of original parts.
- △ For the safety of others and to prevent unnecessary damage to your scooter, do not lend your scooter to those who are unfamiliar with its operation.
- △ You should keep this owner's manual in your vehicle at all times and it should be considered a permanent part of the vehicle.

Precautions

- △ Rider, Passenger and Cargo

This scooter is not designed for more than 2 persons. Do not overload the scooter.

- △ Road Conditions

This scooter is not designed for off-road use.

- △ This User Manual should be deemed as a permanent document of this scooter. If this scooter is transferred to others, this User Manual should also be handed over to the new owner.
- △ Reproduction or reprint of any part of this User Manual is strictly prohibited.

Attention: Do not exceed speed limit and apply brakes cautiously. Always use side stand or central stand when parking.

Warning: Failure to follow the instructions herein may lead to serious casualties, personal injury, or scooter damage.

Safety Notice

- △ Using a safety helmet and protective goggles is strongly advised.
- △ You are advised to take appropriate two-wheel vehicle operational and safety training before using this scooter.
- △ Please follow the Operation Guide (P.15) to fully understand how to properly operate the scooter.
- △ It should be noted that the braking distance in poor weather will significantly increase. Avoid braking on paint markers, manhole covers, and oil stains to prevent slipping. Pay extra attention when riding through railway crossings, junctions, tunnels, and bridges. Slow down if road conditions are unclear.
- △ The addition of unsuitable accessories can result in an unsafe vehicle. Always install Niu approved accessories on your scooter. Your dealer can assist you in selecting and correctly installing accessories.

Safety Notice

- △ Do not use high beam indiscriminately. Continuous use of high beam may disturb the vision of the drivers and pedestrians.
- △ Always perform a pre-ride inspection of your scooter prior to each ride. Review the pre-ride inspection instruction section contained within this manual for more information.
- △ Do not lane-change without signaling. Changing lanes at will is a primary cause of accidents. When you need to perform a lane-change, remember to switch on the Turn Signal Indicator first. Always check for vehicles approaching from behind before changing lanes.
- △ Modification of your scooter or removal of original equipment may render the vehicle unsafe or illegal. Obey all applicable equipment laws and regulations.
- △ Perform any maintenance required per the maintenance schedule or as otherwise necessary to keep your scooter in a safe operating condition. If you notice any odor or notice odd sensations such as vibration, immediately stop your vehicle.

Download APP and Register

- ① Scan the QR code below to download the APP titled NIU Scooter.



- ② Run Setup after downloading and register.

③ Scan the QR code below for scooter binding after registration.



Attach the
SN Code here

Note:

The mobile phone system is required to be at least Android 4.0 or iOS 8. Make sure that the mobile phone has been connected to the Internet when running NIU app (Wi-Fi/2G/3G/4G).

Rapid Installation

- ① Open the Accessories Box to take the tools
- ② Align the windshield rubber part with the windshield holes and then install it.
- ③ Tighten the two screws with a screwdriver to secure the windshield.

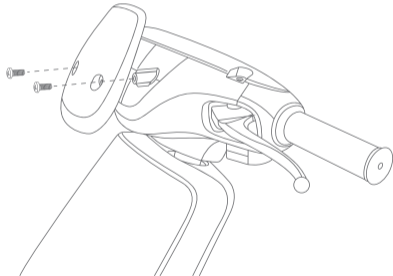
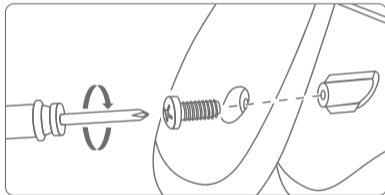

- ④ Install the rearview mirrors into the mounting holes on dashboard and turn it clockwise. The bolt shall be screwed in for more than 15mm.
- ⑤ Adjust the rearview mirror to an appropriate position and then tighten nuts on the rearview mirror with a spanner. Properly set the dust cover.

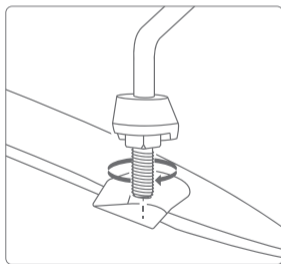
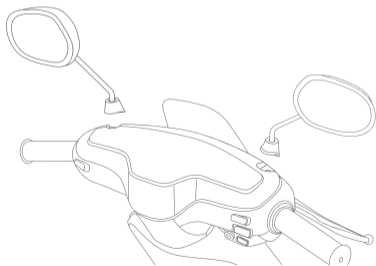

Parts Info

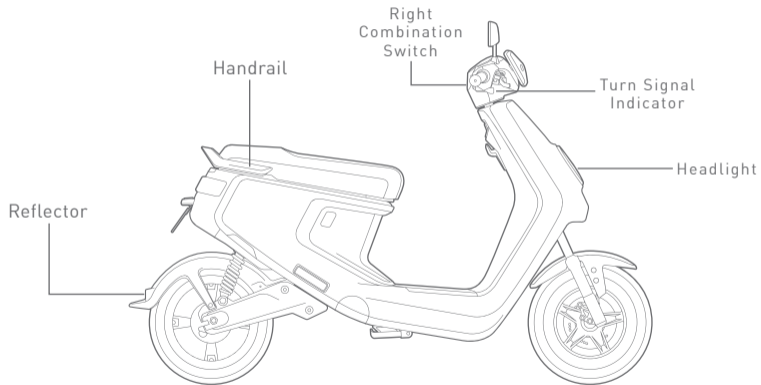



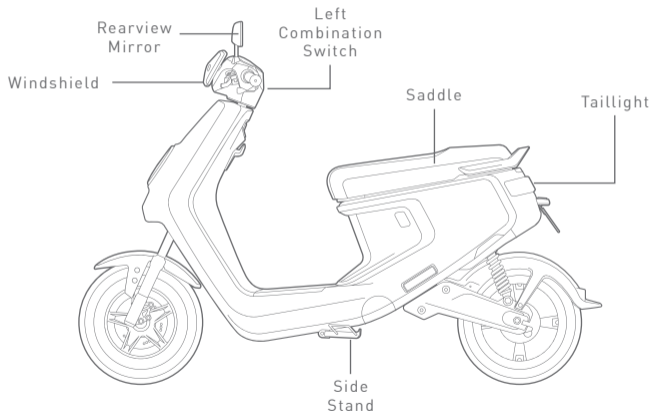

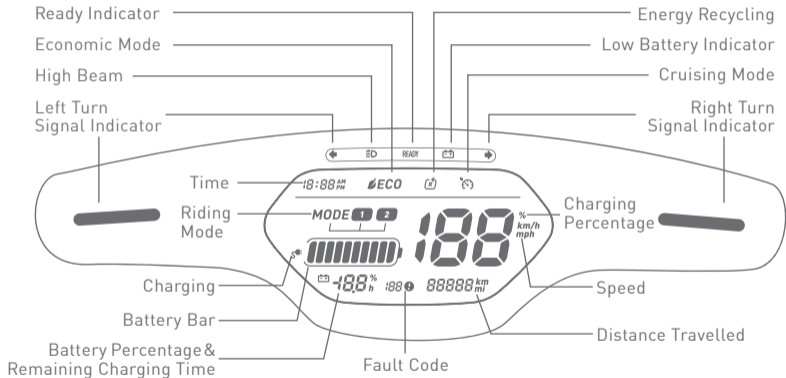

Parts Info



Dashboard Display Info



Dashboard Display Info

	Left Turn Signal Indicator	The Left Turn Signal Indicator is on.
	Right Turn Signal Indicator	The Right Turn Signal Indicator is on.
	High Beam	The High Beam is on.
READY	Ready Indicator	In riding Mode.
	Low Battery Indicator	Battery level less than 20%.
12:00 PM	Time	Now is 12:00 pm.
	Economic Mode	Ideal energy consumption status.
	Energy Recycling Status	Energy is being recycled from braking.
MODE 	Riding Mode	Mode 2 is selected.

Dashboard Display Info

26^{km/h}

Speed

Current speed is 26km/h.

13[%]

Charging Percentage (Large)

Current battery charging progress is 13%.



Battery Bar

Current battery level.

E: Low battery (less than 10%)

F: Full battery (more than 90%)

89[%]

Battery Percentage (Small)

Battery level in percentage is 89%.

- 3.2^h

Remaining Charging Time

The remaining charging time is 3.2 hours.



Charging

The battery is being charged.

00802^{km}

Distance Travelled

Distance Travelled is 802km.

Operation Guide

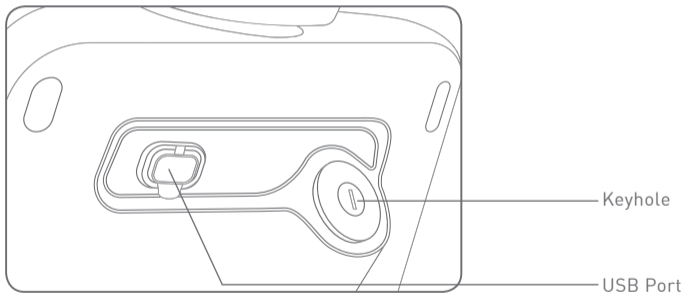

Operation Guide

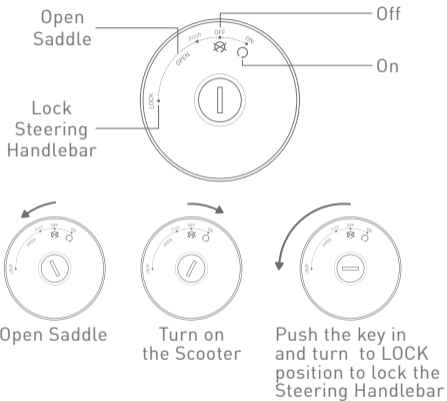

Operation Guide

△ Start the Scooter

Press the Unlock button on the remote control. After the Turn Signal Indicators flash twice, the scooter is unlocked. Insert the key into the Keyhole and turn to . Hold the brake lever in and press and hold the Start Button for 2 seconds. The dashboard will indicate **READY**. You are ready to go.

△ Locking the scooter

Turn the key to  to turn off the scooter. Turn the steering handlebar to the left, then push the key inward and turn to **LOCK** to lock Steering Handlebar. Press the Lock Button on the Remote Controller within an effective distance to turn on the Alarm. The Turn Signal Indicators will stay on for 2 seconds after the scooter is properly locked and armed.

△ Locating

Press the Locate Button and the Turn Signal Indicators will flash for 10 seconds. If no further operations occur during this period, the Alarm will stay on for 10 seconds. The Alarm can be cancelled by pressing the Unlock or Lock Button.

Operation Guide

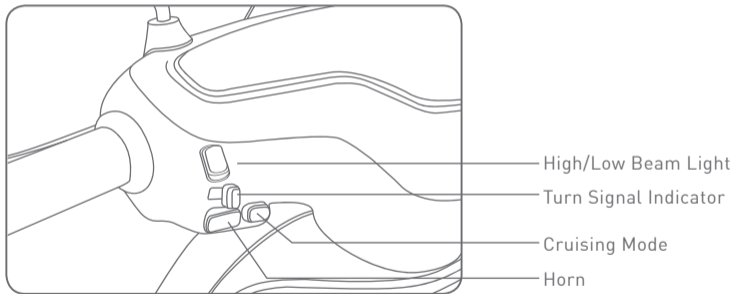

High/Low Beam: Press the top part of the switch to to select high beam; press the bottom part of the switch to switch to select low beam.



Turn Signal Indicator: Push the button left to turn on the Left Turn Signal Indicator; push the button right to turn on the Right Turn Signal Indicator. Press the button to reset and the Turn Signal Indicator will be off.

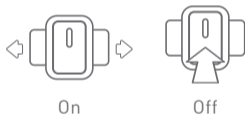

Cruising Mode: Push the button to cruise at current speed. Press again or brake to turn it off.



Operation Guide

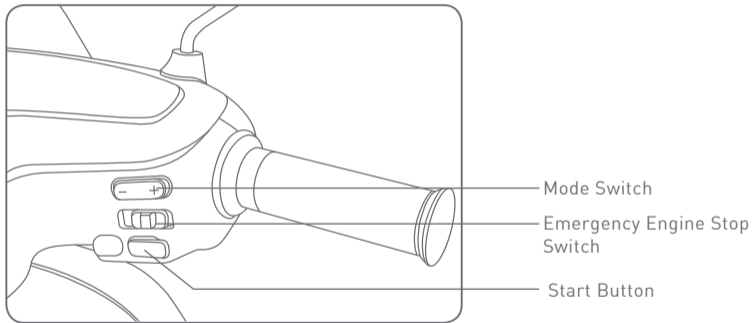

Mode Switch: Press + to switch the mode upward. Press - to switch the mode downward. Higher modes will result in a higher top speed with a lower driving range as a result.

Emergency Engine Stop Switch: Push the switch left to allow power to the motor; push the switch right to disengage power to the motor.

Start Button: With the key in the ON position and brake lever pulled in, press and hold the Start button for 2 seconds to start the scooter. The **READY** on the dashboard will light up. Press the button again to turn it off.

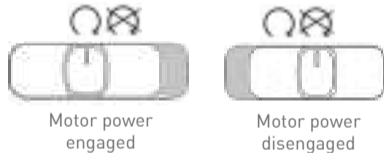

Press to start

Battery Use and Maintenance

△ Battery Level Indicator

- ① When the Indicator Button is pressed, the Indicator will light up to show the percentage of the battery. The indicator has 5 sections. Each presents 20% of the battery level.
- ② If the battery level is less than 20%, the Indicator will flash 3 times.
- ③ When charging, the indicator will flash to show the charging progress. They will stop flashing when the battery is fully charged.
- ④ If all 5 sections flash, it means the battery has fault. Please contact your dealer for consultation.

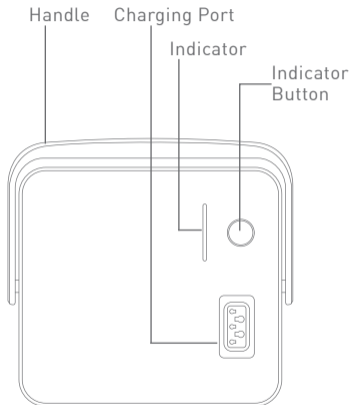

Battery Use and Maintenance

△ Operational Environment

In order to prevent possible leakage, overheat, smoking, fire or explosion, please follow these instructions:

- ① The battery should be used at temperatures between of 15°F to 110°F.
- ② Do not expose battery to water, beverages or corrosive liquids.
- ③ Keep battery away from heat source, open fire, inflammable and explosive gases and liquids.
- ④ Please keep metal parts away from the battery compartment.
- ⑤ In case of undesirable odor, overheat or deformation of the battery, please disuse the battery immediately, keep away from the battery and contact your dealer.

Warning: The M+ battery is NOT a user-repairable part. In the event of battery fault, please contact your dealer. Users disassembling the battery may lead to leakage, overheat, smoking, fire or explosion. **Do not attempt to open or repair the battery, as any attempt to do so will render any implied warranty invalid.**

Battery Use and Maintenance

△ Charging Environment

The battery should be charged at a temperature between 15°F to 95°F. Battery charging time should not exceed 24 hours. Overcharging will shorten the battery life. Do not charge the battery outdoors.

Attention: Do not charge the battery below 32°F.

Warning: Using non-original battery chargers may lead to leakage, overheat, smoking, fire or explosion.

Battery Connector/Charging Port

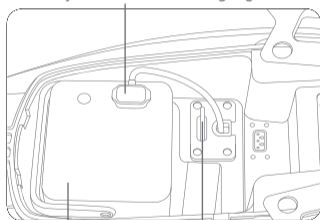

Battery

Battery Lock

Battery Use and Maintenance

△ Charging Methods

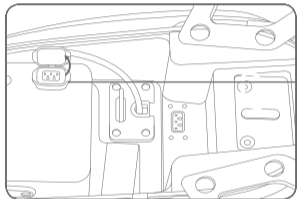

Charging Port

Charging Battery in the Scooter

Open the saddle, open the connector cover, and plug the charger into the charging socket.

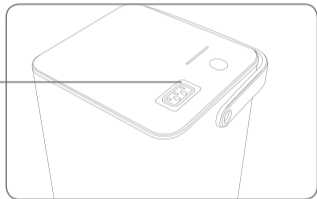

Charging the Battery out of the Scooter

Remove the battery from the scooter. Connect the charger to the battery socket.

Warning:

- △ All operation should be strictly follow instructions in the user manual. If not, any negative result will be assumed by user.
- △ User must use original battery charger and battery as specifically designed for the M+.
- △ Charge in a well-ventilated environment. DO NOT charge in an enclosed space or under high temperature. DO NOT put charger transformer in trunk or top case while charging.
- △ While charging, connect charger to the battery first before connecting charger to an electric outlet. After battery is fully charged, disconnect the charger from the electrical outlet first then disconnect the charger from the battery.
- △ When the charge indicator light turns green, disconnect charger from the electrical socket. Avoid leaving the charger plugged into an electrical socket when not charging a battery.
- △ While charging, if the signal light is abnormal, has an odd odor or the charger is hot, please stop charging immediately and check or change the charger immediately.
- △ When using and storing the charger, please avoid contact with foreign material, especially water or other liquids to prevent an internal short circuit.
- △ DO NOT bring battery charger with scooter unless it is absolutely necessary. If it is necessary, ensure charger is well-protected from impact. NEVER disassemble charger.

Attention:

- △ If the battery cannot be fully charged after 12 hours of charging, please stop charging the battery and contact your dealer.
- △ To maximize battery life, please keep the battery state-of-charge percentage within 20% to 80%.
- △ The battery will lose more capacity in lower temperature conditions. To be more specific, the usable capacity at 15°F is 70%, 85% at 32°F, and 100% at 75°F.
- △ The optimum battery state-of-charge for storage is 50%. Storing battery with less than 10% or more than 90% state-of-charge over a long period of time will cause irreversible capacity loss to the battery.
- △ **The battery must be removed from the scooter for storage longer than one week.** While in storage, please keep the battery at a temperature of 32°F to 68°F with a state-of-charge between 30%-70%. It's advised to have at least one cycle of charge and discharge every 2 months to minimize battery capacity loss during storage.
- △ **If the battery fails due to misuse or lack of proper maintenance as instructed, any implied warranty will be void.**
- △ External Impacts may cause internal damage to the battery and may cause leakage, overheat, smoking, fire or explosion.

Pre-Ride Inspection

△ **Before Each Ride:** Please perform the following inspection.

Check Point	Description
Steering Handlebar	1.Steadiness. Handlebar is not loose or pivoting 2.Steering flexibility from left to right. No binding. 3.No axial displacement or free-play in the steering bearings.
Brakes	1.Brake levers have 5 to 9mm travel free-play. Brake pads are not worn.
Tyres	1. The cold inflation pressure of front and rear tires is 30 psi. 2.Inspect for proper tyre tread depth 3.No cracks or cuts in the tyre.
Battery	No leaks or chemical smell. Adequate charge for planned travel distance.
Lights	Check all the lights—High Beam, Low Beam, Brake Light, Turn Signals, all indicator lights, etc.
Horn	Check whether the horn is functional.

DOs and DON'Ts while Riding

△ Braking Precautions

Maneuver the scooter upright before applying brakes. If the tyres lock and the scooter loses steering ability due to excessive braking force, loosen grip on the brake lever and the tyres will unlock helping the scooter to stabilize. Try to maintain a 1:1 ratio of front to rear braking force on slippery roads. For your safety, do not exceed the speed limit, use the brakes gently to maintain a safe speed while riding downhill.

Attention:

Inexperienced riders tend to use the rear brake only. This will accelerate the wear of the brake resulting in a longer braking distance.

Warning:

Using the front brake or rear brake only is dangerous because of possible loss of grip or control of the scooter. Pay extra attention and use the brakes gently when riding on damp, slippery roads, and around corners. Misuse of the brakes can cause a crash.

Maintenance and Repair

Users are advised to have the scooter checked and maintained on a regular basis, even for the scooters that have not been used for a long time.

△ **Regular Maintenance**

Users are required to have their scooters checked within 3 months after purchased or within 500 miles travelled distance to maintain any warranty. Thorough inspection and maintenance is required every 6 months or every 1750 miles thereafter.

△ **Daily Maintenance**

If any problem is identified during inspection, please ensure the scooter is properly checked and maintained by a qualified technician to ensure the problem is adequately resolved.

△ **Scooter Washing**

Always remove the battery before washing the scooter. Use only mild detergent and water to wash the scooter. Use soft cloth to wipe the scooter after washing.

Attention:

If the scooter is frequently used in overload, high-speed, bumpy or up/downhill riding conditions, the maintenance cycle should be shortened.

For improved quality and longer service life, please use original parts which are designed specifically for this vehicle.

Warning:

If safe and appropriate self-repair or adjustment is not possible, the scooter must be transported to an authorized dealer for maintenance and adjustment. Always choose a smooth surface and use the center-stand for any repairs or adjustments. If it is necessary to repair the scooter during a ride, park the scooter at a safe distance from all traffic.

Warning:

Do not use pressure washer to wash the scooter, especially around the battery compartment. Do not flush water near the rear inner mudguard, where the charger, controller and other parts are installed. If the charging port on the scooter is wet, do not charge before the charger dries completely. Contacting your dealer is recommended if water damage occurs.

Storage Method

△ Short-term Storage:

- ① Keep the scooter in flat, steady, well-ventilated and dry area.
- ② Charge the battery to 50% capacity prior to storage to maximize battery life.
- ③ Avoid exposure to direct sunlight and rain to reduce weather damage and aging.

△ Long-term Storage:

- ① Remember to charge and discharge battery at least every 2 months and to charge the battery to 50% capacity prior to storage to maximize battery life.
- ② Charge the battery to 100% capacity after long-term storage.
- ③ Check all the parts carefully to make sure that there is no problem before riding a scooter that is being returned from a storage condition. If there is any problem, bring the scooter to your dealer for maintenance or repair.

Warning: Please remove the battery from the scooter during long-term storage.

Regular Maintenance Checklist	
Regular Safety and Performance Check	Brakes
	Lights
	Horn
	Electric Parts
	Tyres
Structural Check	Lubrication
	Wheel Bearing
	Vibration Damper
	Side Stand
	Steering Bearing
Major Parts	Battery
	Main Wiring Harness
	Control System

Troubleshooting List		
Malfunction Description	Causes	Troubleshooting
No output when switched on	<ol style="list-style-type: none"> 1. Dead battery 2. Battery not connected 3. Alarm failure 	<ol style="list-style-type: none"> 1. Charge the battery. 2. Check if it's properly connected 3. Contact your dealer for inspection
Motor failure when turning the twist grip after switched on	<ol style="list-style-type: none"> 1. Battery level is low 2. The power off switch is enabled when pulling the brake lever 3. The Parking Mode has not been turned off yet 	<ol style="list-style-type: none"> 1. Charge the battery. 2. Do not pull the brake lever and apply throttle simultaneously. 3. Check "Start the Scooter" section. Check if the side stand is on.
Battery charge failure	<ol style="list-style-type: none"> 1. Not properly connected 2. Battery temperature is too high or too low 	<ol style="list-style-type: none"> 1. Check whether the plug is loose. 2. Wait for battery to achieve normal temperature

Troubleshooting List		
Malfunction Description	Causes	Troubleshooting
Dropping speed or range	<ol style="list-style-type: none"> 1. Low battery level 2. Under-inflation of tyres 3. Frequent braking and overload 4. Battery aging or normal capacity loss 5. Low battery capacity resulting from low temperature 	<ol style="list-style-type: none"> 1. Charge the battery and check if the plug is properly plugged in and whether the charger is damaged. 2. Check the tyre inflation before each ride. 3. Develop good riding habits. 4. Replace the battery. 5. Normal situation.
Sudden stop during a ride	Dead battery	Charge the battery.
	Identify the fault causes in reference to the meter panel fault codes.	

Fault Code List			
Fault Code	Meaning	Causes	Troubleshooting
30	Battery overcharged	Battery in overcharge protection	Turn on headlight to discharge. Check if the charger is broken or wrong type.
31	Charging overcurrent	Battery in overcurrent protection	Stop charging and check if the charger has failed.
32	Charging low temperature	Battery is too cold to charge.	Bring the battery indoor until battery temperature is normal.
130	Battery overdischarge	Battery level is too low and the BMS is about to enter protection mode	Stop riding and charge the battery.
131	Battery overcurrent	Battery is undervoltage or overvoltage	Check if the charger is failed.
132	Battery over-temperature	Battery temperature is too high	Stop riding and park the bike in the shade to let the battery cool down.

Fault Code List			
Fault Code	Meaning	Causes	Troubleshooting
133	Battery below-temperature	Battery temperature is too low	Charge the battery after it reaches the operating temperature range.
60	Communication Module failure	SIM card identification failure	Contact your dealer.
67		SIM card unpaid or weak signal	
62		GPS failure	
63		GPS Antenna short circuit	
64		GPS Antenna open circuit	
65		SN code are not written or Smart central controller serial code are not written	

Fault Code List			
Fault Code	Meaning	Causes	Troubleshooting
10	FOC stop working	Motor stucked	Check if the motor is stucked.
11		Undervoltage or overvoltage	Check if the charger is intact.
12		Overcurrent	Contact your dealer if happens often.
13		Controller overheat	Park the bike in shade and wait for it to cool down.
110	FOC failure	MOSFET failure	Contact your dealer.
		MOSFET driver failure	
111	FOC varification failure	Non-original Controller or communication failure	Restart the bike. Contact your dealer if it does not work.
190	FOC Communication failure	Can not receive Controller's data	Contact your dealer.

Fault Code List			
Fault Code	Meaning	Causes	Troubleshooting
120	Motor failure	Motor Hall Sensor failure	Contact your dealer.
		Motor cord disconnected	
140	Twist Grip failure	Twist Grip Hall Sensor failure	Contact your dealer.
191	Battery communication failure	BMS can't return data or returned data is incorrect	Check the Connector is properly plugged. Contact your dealer if happens often.
99	Communication Harness failure	Smart Central Controller or Harness Assembly failure	Contact your dealer.
71	Light Control	Gyroscope failure	Contact your dealer.
161	Locked bike	The bike is remotely locked by the server.	Contact your dealer.

Troubleshooting List		
Malfunction Description	Causes	Troubleshooting
131 displayed	Over discharging	Stop the scooter and restart later.
132 displayed	Battery overtemperature	Stop riding and let the battery cool down.
133 displayed	Battery undertemperature	Charge the battery after it reaches the operating temperature range.

Technical Parameters

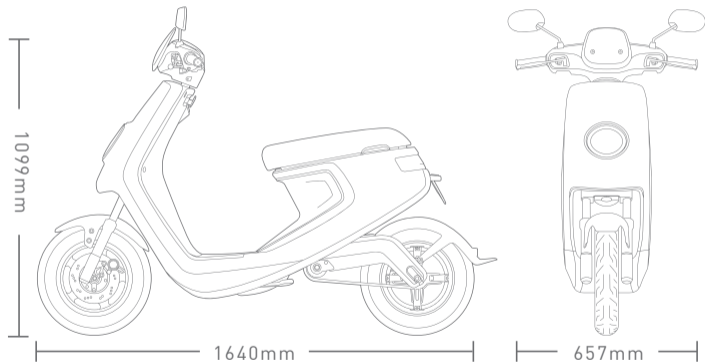

Key Features			
Product Weight	72Kg	Gradeability	Dynamic: 15°
Rated Voltage	48V	Maximum Designed Speed	48km/h
Maximum Load	172Kg	Braking Distance	≤4.5m (30km/h)
Designed Capacity		1 or 2 Persons	

Battery System	
	M+ Sport
Voltage	48V
Capacity	42Ah
Standard Charging Current	4A
Maximum Discharging Current	40A

Frame	
Front Damper	Oil Damping Direct Acting Shock Absorber
Rear Damper	Rear Mono-Shock
Front Tyre Specifications	90/90-10 Rim: 2.15x10
Rear Tyre Specifications	90/90-10 Rim: 2.15x10
Front Brake Mode	180 mm Dual-Piston Hydraulic Disk Brake
Rear Brake Mode	Drum Brake
Minimum Ground Clearance	126mm
Seat Height	710mm

Power System	
	M+ Sport
Motor	Tailored Motor by Bosch GmbH
Motor Control Mode	FOC Vector Control
Motor Rated Power	1200W
Motor Maximum Power	1490W
FOC Controller Max. Current	40A

Electrical System	
Headlight	12V LED
Turn Indicator	12V LED
Taillight	12V LED
Brake Light	12V LED
Meter Panel	12V LCD
Central Control Unit	12V
USB Charging	5V/1A

Maintenance Record

Date	Malfunction Description	Causes and Troubleshooting	Service Station	Serviced by	Remarks

Maintenance Record

Date	Malfunction Description	Causes and Troubleshooting	Service Station	Serviced by	Remarks

Maintenance Record

Date	Malfunction Description	Causes and Troubleshooting	Service Station	Serviced by	Remarks

Maintenance Record

Date	Malfunction Description	Causes and Troubleshooting	Service Station	Serviced by	Remarks

Reporting Safety Defects

If you believe that your vehicle has a defect which could cause a crash or could cause injury or death, you should immediately inform the National Highway Traffic Safety Administration (NHTSA) in addition to notifying NIU. If NHTSA receives similar complaints, it may open an investigation, and if it finds that a safety defect exists in a group of vehicles, it may order a recall and remedy campaign. However, NHTSA cannot become involved in individual problems between you, your dealer, or NIU. To contact NHTSA, you may call the Vehicle Safety Hotline toll-free at 1-888-327-4236 (TTY: 1-800-424-9153); go to <http://www.safercar.gov>; or write to: Administrator, NHTSA, 400 Seventh Street, SW., Washington, DC 20590. You can also obtain other information about motor vehicle safety from <http://www.safercar.gov>.

Battery Recycling

All batteries must be recycled after their useful life.

Batteries should be taken to a household hazardous waste disposal facility, a universal waste handler, or an authorized recycling facility. Batteries are considered hazardous waste because of the metals and/or other toxic or corrosive materials contained within.

Improper disposal of batteries may be a violation of federal, state or local laws.

Consult with your dealer for the proper methods and locations for battery recycling.



V1.5