

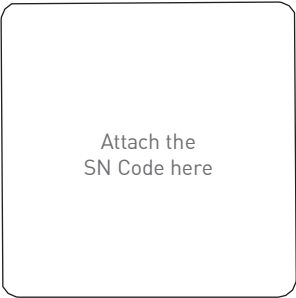

**USER MANUAL**



Attach the  
SN Code here

The SN Code of your scooter.  
Please see P.7 and P.8 for  
detailed information.

This owner's manual contains important safety, operational and maintenance information. Any person operating or riding as a passenger on your scooter should carefully read and fully understand the entire contents of this manual prior to riding the vehicle. For your safety, follow all safety warnings contained within the owner's manual and the labels applied to your scooter.

If you have any questions, please ask your dealer for assistance.



## WARNING California Proposition 65

Lithium-ion Batteries and/or products that contain Lithium-ion Batteries can expose you to chemicals including cobalt, lithium, nickel oxide, and nickel, which are known to the State of California to cause cancer and birth defects or other reproductive harm.

For more information go to  
[www.P65Warnings.ca.gov](http://www.P65Warnings.ca.gov)

## CONTENTS

General Notice.....	1
Precautions .....	2
Safety Notice .....	3
Installation Guide.....	4
Downloading the App.....	7
Parts Info .....	9
Dashboard Display Info .....	11
Operation Guide .....	14
Battery Use and Maintenance Guide .....	21
DOs and DON'Ts while Riding .....	25
Maintenance and Repair .....	27
Regular Maintenance Checklist .....	30
Technical Parameters .....	37
Maintenance Record .....	41
Battery Recycling .....	48
Reporting Safety Defects .....	49

## General Notice

- △ Please read this User Manual carefully for proper operation before riding the scooter.
- △ For your safety, please check whether all parts of the scooter are in good working condition according to this User Manual before riding. Contact your dealer immediately in the event you encounter any problems.
- △ Please follow the traffic laws. Slow down on slippery roads in bad weather to allow greater braking distance for your safety.
- △ Please pay attention to deep water. It may cause corrosion or failure of the motor, battery, or other parts if water level reaches above the wheel axle.
- △ Do not dismantle the scooter on your own. Please contact your dealer for replacement or purchase of original parts.
- △ For the safety of others and to prevent unnecessary damage to your scooter, do not lend your scooter to those who are unfamiliar with its operation.
- △ You should keep this owner's manual in your vehicle at all times and it should be considered a permanent part of the vehicle.

## Precautions

- △ Rider and Passenger

**This scooter is not designed for more than 2 persons.**

- △ Road Conditions

This scooter is not designed for off-road use.

- △ This User Manual should be deemed as a permanent document of this scooter. If this scooter is transferred to others, this User Manual should also be handed over to the new owner.
- △ Reproduction or reprint of any part of this User Manual is strictly prohibited.

**Attention:** Do not exceed speed limit and apply brakes cautiously. Always use side stand or central stand when parking.

**Warning:** Failure to follow the instructions herein may lead to serious casualties, personal injury, or scooter damage.

## Safety Notice

- △ Using a helmet and protective goggles is strongly advised.
- △ You are advised to take appropriate two-wheel vehicle operational and safety training before using this scooter.
- △ Please follow the Operation Guide (P.14) to fully understand how to properly operate the scooter.
- △ It should be noted that the braking distance in poor weather will significantly increase. Avoid braking on paint markers, manhole covers, and oil stains to prevent slipping. Pay extra attention when riding through railway crossings, junctions, tunnels, and bridges. Slow down if road conditions are unclear.
- △ Do not use high beam indiscriminately. Continuous use of high beam may disturb the vision of other drivers and pedestrians.
- △ Do not use mobile phones or other electronic devices which may draw your attention while riding.
- △ Do not lane change without signaling. Changing lanes at will is a primary cause of accidents. When you need to perform a lane change, remember to switch on the Turn Signal Indicator first. Always check the vehicles approaching from behind before changing lanes.

## Installation Guide

- ① Insert the key to the main lock and turn to the icon of "OPEN" as shown in the figure to the right.

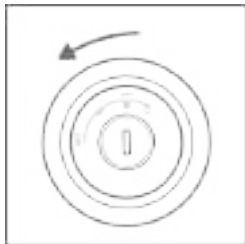

- ② Open the seat to remove the key box, windshield package (with rubber pads and standard parts), and installation tools.

Insert the key into the keyhole in the rear storage and turn it to open the battery compartment. Take out the charger and rearview mirrors package inside.

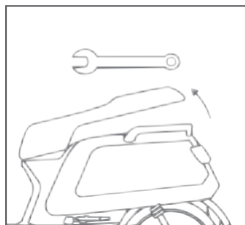



## Installation Guide

- ③ Take out the rearview mirrors and check them carefully. Install the left rearview mirror into the mounting hole on the left brake lever and turn it clockwise. The bolt shall be screwed in for more than 15mm.



- ④ Adjust the rearview mirrors to an appropriate position and then tighten nuts on the rearview mirror with a spanner. Properly set the dust cover.

Install the right rearview mirror in the same way.

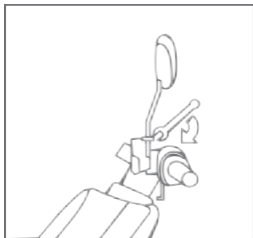

- ⑤ Align the windshield rubber part with the windshield holes and then install it.
- ⑥ Tighten the two screws with the screwdriver to secure the windshield.

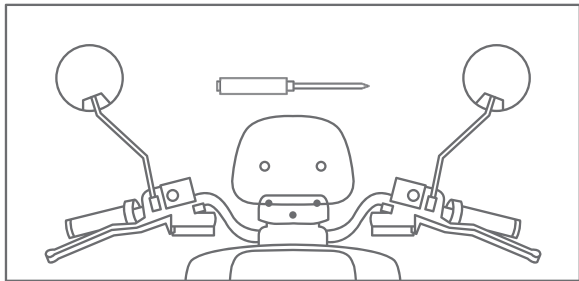

## Downloading the APP

Functions such as checking battery level, locating, and management can be implemented on the electric scooter through the app.

- ① Scan the QR code below to download the APP titled *Niu E-Scooter*.



- ② Run Setup after downloading and register.
- ③ Please scan the QR code **on the inside of cover page** for app registration.

**Note:**

The mobile phone system is required to be at least Android 4.0 or iOS 8. Make sure that the mobile phone is connected to the Internet when running the app (Wi-Fi / 3G / 4G / 5G).



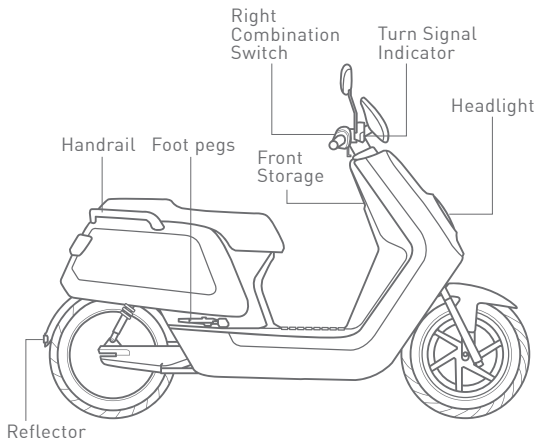

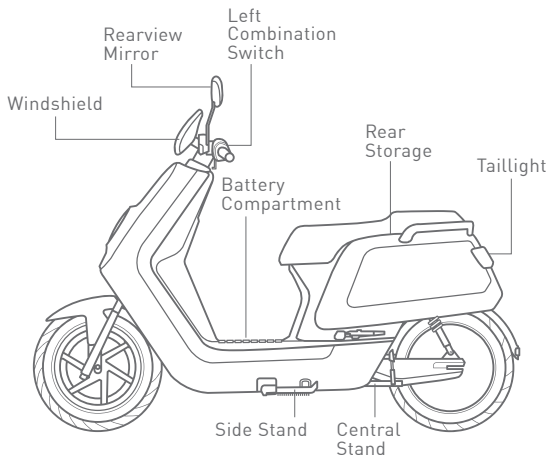



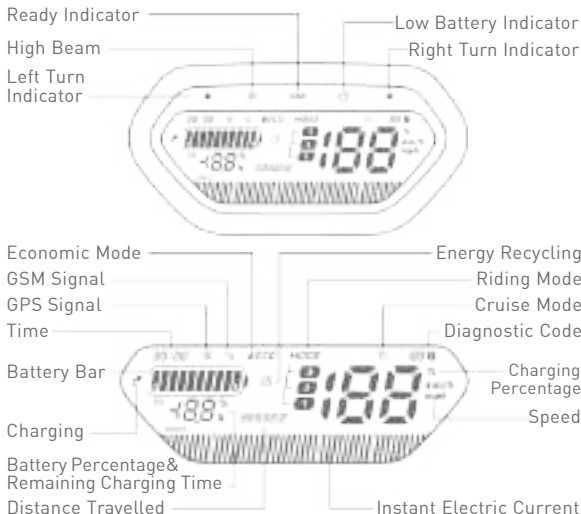



## Parts Info













## Dashboard Display Info



	Left Turn Indicator	The Left Turn Indicator is on.
	Right Turn Indicator	The Right Turn Indicator is on.
	High Beam	The High Beam is on.
	Ready Indicator	In Riding Mode.
	Low Battery Indicator	Battery level less than 10%.
	Time	Now is 10:00
	Economic Mode	Ideal energy consumption status.
	GPS Signal	No flashing: Signal strong. Bars are flashing: Signal weak.
	GSM Signal	Entire icon flashing: No signal.
	Cruise Mode	The scooter is in Cruise Mode.
	Diagnostic Code	The Diagnostic Code is 30. Please see P.34-37 for details.
	Energy Recycling Status	Energy is being recycled from braking.



## Dashboard Display Info

	Battery Bar	Current battery level is 80~89%.
	Battery Percentage (Small)	Current battery level is 85%.
	Remaining Charging Time	The remaining charging time is 3.2h (using scooter charging port).
	Charging	Battery is being charged.
	Distance Travelled	Distance Travelled is 802km.
	Instant Electric Current	Indicates instant power output.
	Riding Mode	Mode 2 is selected.
	Speed	Current speed is 26km/h.
	Charging Percentage (Large)	Current battery charging progress is 13% (using scooter charging port).

## Operation Guide

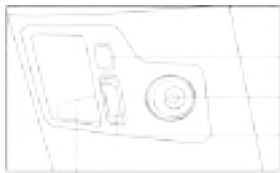

### △ Front Storage Area

- 1 USB Charging Port
- 2 Main Lock
- 3 Hook
- 4 Front Storage



### △ Left Combination Switch

- 1 High/Low Beam
- 2 Turn Signal Indicator
- 3 Cruising Mode
- 4 Horn

## Operation Guide

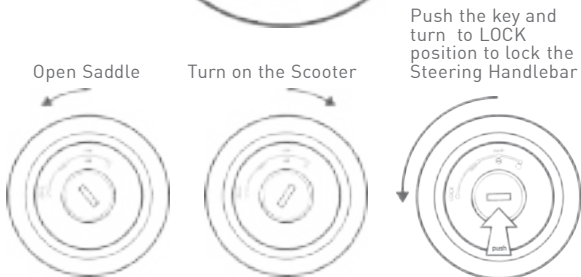
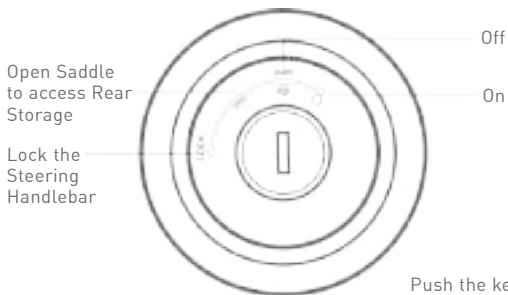

- ① High/Low Beam: Press the top part to switch to high beam; press the bottom part to switch to low beam.



Remarks: To signal overtaking with flashing light, the rider may press and release the top part of the button repeatedly.

- ② Turn Signal Indicator: Push the button left to turn on the Left Turn Signal Indicator; push the button right to turn on the Right Turn Signal Indicator. Press the button to turn off.



- ③ Cruising Mode: Push the button to cruise at current speed. Press again or brake to turn it off.



## Operation Guide



### Right Combination Switch

1 Mode Selector

2 Emergency Kill Switch

3 Start/Stop Button

- ① Mode Selector: Press + to switch the mode upward. Press - to switch the mode downward. Higher modes will result in a higher top speed with a lower driving range as a result.

Lower Mode



Higher Mode

- ② Emergency Kill Switch: Push the switch left to turn on the Scooter On; push the switch right to turn it off.

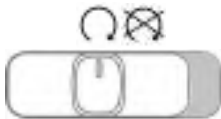

Turn on the Scooter

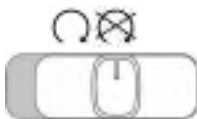

Turn off the Scooter

- ③ Start/Stop Button: **Press and hold the button for 2 seconds while holding the brake lever** in to set the scooter in the riding mode. The **READY** indicator on the dashboard will light up and you are ready to drive. Press the button again to turn off the scooter.



## Operation Guide

### ▲ Start the Scooter

- ① Press the Unlock button on the remote controller. After the Turn Signal Indicators flash twice, the scooter is unlocked.
- ② After the scooter is unlocked, insert the key into the Keyhole and turn clockwise to  position.
- ③ After system diagnostic, hold the brake and press the Start Button for 2 seconds.
- ④ The **READY** indicator will light up. Release the brake and the scooter will be ready to go.

Locating Button

Unlock Button

Lock Button



Remote Controller

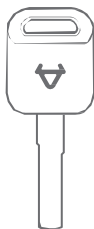

Key

△ **Locking Steering Handlebar**

Turn the steering handlebar fully to the left, then push the key inward and turn it counterclockwise to LOCK position.

△ **Locking with Remote Controller**

The scooter can only be locked when the scooter is turned off. Press the Lock Button on the Remote Controller within an effective distance to turn on the Alarm. The Turn Signal Indicators will stay on for 2 seconds after the scooter is properly locked.

△ **Locating**

Press the Locating Button and the Turn Signal Indicators will flash for 10 seconds. If no further operation during this period, the Alarm will be on for 10 seconds. The Alarm can be cancelled by pressing the Unlock or Lock Button.



## Battery Use and Maintenance Guide

### △ Battery Use Conditions

- ① In order to prevent possible leakage, overheat, smoking, fire or explosion, please follow these instructions:
- ② Battery should be used at temperatures between 15°F to 110°F.
- ③ Do not expose battery to water, beverages or corrosive liquids.
- ④ Keep battery away from heat sources, open fire, flammable and explosive gases and liquids.
- ⑤ Please keep metal parts away from the battery compartment.

In the event you experience an undesirable odor, overheating or deformation of the battery, please stop using the battery immediately, keep away from the battery and contact your dealer.

**Warning:** The battery is not a user-repairable part. In the event of battery fault, please contact your dealer. Users dismantling the battery may lead to leakage, overheat, smoking, fire or explosion. This will invalidate any warranty.

△ **Battery Charging Conditions**

Battery should be charged at temperatures between 15°F to 95°F. Battery charging time should not exceed 24 hours, or it will shorten the battery life. Do not charge the battery outdoors.

**Attention:** Do not charge the battery below 32°F.

**Warning:** Using non-original battery chargers may lead to leakage, overheat, smoking, fire or explosion.

Battery Compartment Cover

Battery Compartment Lock

Battery

Battery Compartment

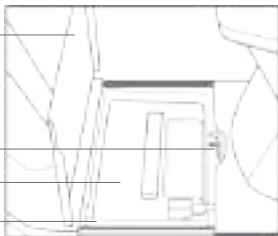

## Battery Use and Maintenance Guide

### △ Battery Charging Methods

#### Charging Battery in the Scooter

- ① Open the saddle with the key, plug the charging plug into the charging port.
- ② Once the charging indicator turns from green to red, charging has started.
- ③ Turn on the scooter during charging to show the progress on the dashboard.



Charging Port on the Scooter

#### Charging Battery out of the Scooter

- ① Remove the battery from the scooter.
- ② Connect the charger to the battery socket. When the charger indicator light is red, the battery is being charged.
- ③ After the charger indicator light turns from red to green, charging has completed.

Battery Charging Port



**Warning:**

- △ All operation should be strictly follow instructions in the user manual. If not, any negative result will be assumed by user.
- △ Must use original battery charger.
- △ Pay attention to the type of battery and applied voltage. Using batteries not specified for this model is forbidden.
- △ Charging should occur in a ventilated environment. DO NOT charge in closed space or under high temperature. DO NOT put charger transformer into trunk or top case while charging.
- △ While charging, connect battery with charger before connecting with an electric supply outlet. After fully charged, disconnect the electric supply before unplugging the battery plug.
- △ When the green light turns on, disconnect the power source.
- △ Avoid leaving the charger plugged into an electrical source when not charging a battery.
- △ While charging, if the signal light is abnormal, has odor, or the charger is extremely hot, please stop charging immediately and check or change the charger quickly.
- △ When using and storing the charger, please avoid foreign material such as water or other liquids to prevent an internal short circuit.
- △ DO NOT bring charger with scooter if possible, if you must, please make sure to protect charger with cushioned material.
- △ DO NOT disassemble or change the parts on the charger.

**Attention:**

- △If the battery cannot be fully charged after 12 hours of charging, please stop charging the battery and contact your dealer.
- △To maximize battery life, please keep the battery state-of-charge percentage within 20% to 80%.
- △The battery will lose more capacity in lower temperature conditions. To be more specific, the usable capacity at 15°F is 70%, 85% at 32°F, and 100% at 75°F.
- △The best battery capacity performance for storage is 50%. Storing battery with less than 10% or more than 90% over a long period of time will cause irreversible capacity loss to the battery.
- △**The battery must be removed from the scooter for storage longer than one week.** While in storage, please keep the battery at a temperature of 32°F to 68°F with a state-of-charge between 30%-70%. It's advised to have at least one cycle of charge and discharge every 2 months to minimize battery capacity loss during storage.
- △**If the battery fails due to misuse or lack of proper maintenance as instructed, any implied warranty will be void.**
- △External Impacts may cause internal damage to the battery and may cause leakage, overheat, smoking, fire or explosion.

## DOs and DON'Ts while Riding

### Pre-Ride Inspection

△ Before Each Ride: Please perform the following inspection.

Check Point	Description
Steering Handlebar	1) Steadiness. Handlebar is not loose or pivoting. 2) Steering flexibility from left to right. 3) No axial displacement or free-play
Braking	1) Brake levers have 5 to 9mm travel free-play.
Tyres	1) The cold inflation pressure of the front tyre is 30 psi; the cold inflation pressure of the rear tyre is 30 psi. 2) Inspect for proper tyre tread depth 3) No cracks or cuts in the tyre.
Battery	Adequate charge for planned travel distance.
Lights	Check all the lights—High Beam, Low Beam, Brake Light, Turn Signal Indicator, etc.
Horn	Check whether the horn is functional.

## DOs and DON'Ts while Riding

### △ Braking Precautions

Maneuver the scooter upright before applying brakes. If the tyres lock and the scooter loses steering ability due to excessive braking force, loosen grip on the brake lever and the tyres will unlock helping the scooter to stabilize. Try to maintain a 1:1 ratio of front to rear braking force on slippery roads.

**Caution:**

For your safety, do not exceed the speed limit, use the brakes gently to maintain a safe speed while riding downhill.

**Attention:**

Inexperienced riders tend to use the rear brake only. This will accelerate the wear of the brake resulting in a longer braking distance.

**Warning:**

Using the front brake or rear brake only is dangerous because of possible loss of grip or control of the scooter. Pay extra attention and use the brakes gently when riding on dams, and around corners. Misuse of the brakes can expose the rider to great danger.

## Maintenance and Repair

Users are advised to have the scooter checked and maintained on a regular basis. Scooters that have not been used for a long time should be thoroughly inspected.

### △ **Regular Maintenance**

Users are advised to have their scooters inspected 3 months after purchase or within 500 miles of travelled distance. Overall inspection and maintenance is advised to be conducted every 6 months or 1750mi thereafter.

### △ **Daily Maintenance**

If any problem is identified during inspection, please ensure the scooter is properly checked and maintained by a qualified technician to ensure the problem is adequately resolved.

### △ **Scooter Washing**

Always remove the battery before washing the scooter. Please use mild detergent and water to wash the scooter. Use soft cloth to wipe the scooter after washing to prevent scratching.



**Attention:**

If the scooter is frequently used in overload, high-speed, bumpy or up/downhill riding conditions, the maintenance cycle should be shortened.

For improved quality and longer service life, please use original parts which are designed specifically for this vehicle.

**Warning:**

If safe and appropriate self-repair or adjustment is not possible, the scooter must be transported to an authorized dealer for maintenance and adjustment. Always choose a smooth surface and use the center-stand for any repairs or adjustments. If it is necessary to repair the scooter during a ride, park the scooter at a safe distance from all traffic.

**Warning:**

Do not use pressure washer to wash the scooter, especially around the battery compartment. Do not flush water near the rear inner mudguard, where the charger, controller and other parts are installed. If the charging port on the scooter is wet, do not charge before the charger dries completely. Contacting your dealer is recommended if water damage occurs.

## Maintenance and Repair

### △ Short-term Storage:

- ① Keep the scooter in flat, steady, well-ventilated and dry area.
- ② Charge the battery to 50% capacity prior to storage to maximize battery life.
- ③ Avoid exposure to direct sunlight and rain to reduce weather damage and aging.

### △ Long-term Storage:

- ① Remember to charge and discharge battery at least every 2 months and to charge the battery to 50% capacity prior to storage to maximize battery life.
- ② Charge the battery to 100% capacity after long-term storage.
- ③ Check all parts carefully to make sure that there is no problem before riding a scooter that is being returned from a storage condition. If there is any problem, bring the scooter to your dealer for maintenance or repair.

**Warning:** Please disconnect the battery from the scooter during storage.

<b>Regular Maintenance Checklist</b>	
Regular Safety and Performance Check	Brakes
	Lights
	Horn
	Electric Parts
	Tyres
Structural Check	Lubrication
	Wheel Bearings
	Suspension Components
	Central Stand
	Steering Bearings
Major Parts	Battery
	Main Wiring Harness
	Control System

<b>Troubleshooting List</b>		
<b>Malfunction Description</b>	<b>Causes</b>	<b>Troubleshooting</b>
No output when powered on	<ol style="list-style-type: none"> <li>1. Battery disconnect</li> <li>2. Dead battery</li> <li>3. Alarm failure</li> </ol>	<ol style="list-style-type: none"> <li>1. Connect the battery.</li> <li>2. Charge the battery.</li> <li>3. Contact your dealer for inspection.</li> </ol>
Motor failure when turning the twist grip after vehicle is powered on	<ol style="list-style-type: none"> <li>1. Battery level is low</li> <li>2. The motor power is interrupted when brake lever is on.</li> <li>3. The Parking Mode has not been turned off yet</li> </ol>	<ol style="list-style-type: none"> <li>1. Charge the battery.</li> <li>2. Do not pull the brake lever and apply throttle simultaneously.</li> <li>3. Check "Start the Scooter" section of this Manual.</li> </ol>
Battery charge failure	<ol style="list-style-type: none"> <li>1. The plug of the battery is not properly connected with the battery socket</li> <li>2. Battery is overdischarged</li> </ol>	<ol style="list-style-type: none"> <li>1. Check whether the plug is loose.</li> <li>2. Contact your dealer for inspection.</li> </ol>

<b>Troubleshooting List</b>		
<b>Malfunction Description</b>	<b>Causes</b>	<b>Troubleshooting</b>
Dropping speed or range	<ol style="list-style-type: none"> <li>1. Low battery level</li> <li>2. Under-inflation of tyres</li> <li>3. Frequent braking and overload</li> <li>4. Battery aging or normal capacity loss</li> <li>5. Low battery capacity resulting from low temperature</li> </ol>	<ol style="list-style-type: none"> <li>1. Charge the battery.</li> <li>2. Check the tyre inflation pressure.</li> <li>3. Develop good riding habits.</li> <li>4. Replace the battery.</li> <li>5. Normal situation.</li> </ol>
Sudden stop during a ride	Dead battery	Charge the battery.
	Identify the fault causes in reference to the Diagnostic Codes on Dashboard. Contact your dealer if the troubleshooting methods listed in this manual is not working.	

<b>Troubleshooting List</b>		
<b>Malfunction Description</b>	<b>Causes</b>	<b>Troubleshooting</b>
00 displayed	Communication failure or Dashboard failure	<ol style="list-style-type: none"> <li>1. Disconnect the battery and reconnect it after 30 seconds.</li> <li>2. Check whether the wires are loosened.</li> <li>3. Contact your dealer for inspection.</li> </ol>
10 displayed	FOC Controller locked rotor	Stop the scooter and restart later.
11 displayed	FOC Controller under-voltage/ over-voltage	Stop the scooter and restart later.
12 displayed	FOC Controller overcurrent	Contact your dealer for inspection.
13 displayed	FOC Controller over-temperature	Disconnect the battery and cool it down before reuse.
20 displayed	Motor over-temperature	Stop the scooter and restart when cooled down.

<b>Troubleshooting List</b>		
Malfunction Description	Causes	Troubleshooting
30 displayed	Battery overcharged	Turn on the headlight and hazard light to discharge until the code disappears.
31 displayed	Charging overcurrent	Stop charging the battery and check if the charger is failed.
32 displayed	Charging at low temperature	Take the battery indoor until back to normal operating temperature.
60 displayed	SIM card identification failure	Contact your dealer for inspection.
62 displayed	GPS module failure	
63 displayed	GPS antenna short circuit	
64 displayed	GPS antenna open circuit	
65 displayed	ECU SN missing/incorrect	

<b>Troubleshooting List</b>		
<b>Malfunction Description</b>	<b>Causes</b>	<b>Troubleshooting</b>
67 displayed	SIM card unpaid/ inactivated/low signal strength	Contact your dealer for inspection.
99 displayed	Electronic components communication failure	Contact your dealer for inspection.
110 displayed	FOC Controller failure	Contact your dealer for inspection.
111 displayed	1. The scooter is locked 2. FOC Controller verification failure	1. Press unlock button on the Remote. 2. Contact your dealer for inspection.
120 displayed	Motor failure	Contact your dealer for inspection.
130 displayed	Battery over-discharged	Charge the battery.
131 displayed	Over-current discharging	Stop the scooter and restart later.



<b>Troubleshooting List</b>		
<b>Malfunction Description</b>	<b>Causes</b>	<b>Troubleshooting</b>
132 displayed	Battery over-temperature	Stop riding and let battery cool down.
133 displayed	Battery under-temperature	Charge the battery after it reaches the operating temperature range.
140 displayed	Twist grip failure	Please check the wires of the twist grip or contact your dealer for inspection.
161 displayed	The scooter is locked by remote command	Contact your dealer for inspection.
190 displayed	Controller communication failure	Contact your dealer for professional checks.
191 displayed	BMS communication failure	Contact your dealer for professional checks.

## Technical Parameters

Key Features			
Product Weight	209 lbs	Gradeability	Dynamic: 15°
Rated Voltage	60V	Maximum Designed Speed	Mode 1: 12 mph Mode 2: 20 mph Mode 3: 30 mph
Maximum Load	441 lbs	Braking Distance	≤15ft (18 mph)
Designed Capacity	2 Persons		

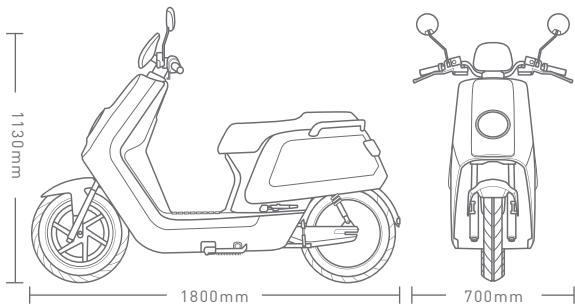

## Technical Parameters

<b>Frame</b>	
Front Damper	Oil Damping Direct Acting Shock Absorber
Rear Damper	Oil Damping Direct Acting Shock Absorber
Front Tyre Specifications	90/90-12 Rim: 2.15x12
Rear Tyre Specifications	120/70-12 Rim: 3.50x12
Front Brake Mode	220 mm Dual-Piston Hydraulic Disk Brake
Rear Brake Mode	180 mm Dual-Piston Hydraulic Disk Brake
Minimum Ground Clearance	145mm
Seat Height	740mm

<b>Battery System</b>	
Voltage	60V
Capacity	29Ah
Standard Charging Current	4A
Maximum Discharging Current	40A

<b>Power System</b>	
Motor	Tailored Motor by Bosch GmbH
Motor Control Mode	FOC Vector Control
Max. Motor Continuous Power	30 mph Version: 1490W
Controller Maximum Current	40A

<b>Electrical System</b>	
Headlight	12V LED
Turn Indicator	12V LED
Taillight	12V LED
Brake Light	12V LED
Meter Panel	12V LCD
Central Control Unit	12V
USB Charging	5V/1A

## Maintenance Record

Date		Mileage	
Notes			
Dealer			

## Maintenance Record

Date		Mileage	
Notes			
Dealer			

## Maintenance Record

Date		Mileage	
Notes			
Dealer			

## Maintenance Record

Date		Mileage	
Notes			
Dealer			



## Maintenance Record

Date		Mileage	
Notes			
Dealer			

## Maintenance Record

Date		Mileage	
Notes			
Dealer			

## Maintenance Record

Date		Mileage	
Notes			
Dealer			

## Battery Recycling

**All batteries must be recycled after their useful life.**

Batteries should be taken to a household hazardous waste disposal facility, a universal waste handler, or an authorized recycling facility. Batteries are considered hazardous waste because of the metals and/or other toxic or corrosive materials contained within.

**Improper disposal of batteries may be a violation of federal, state or local laws.**

Consult with your dealer for the proper methods and locations for battery recycling.

## **Reporting Safety Defects**

If you believe that your vehicle has a defect which could cause a crash or could cause injury or death, you should immediately inform the National Highway Traffic Safety Administration (NHTSA) in addition to notifying NIU.

If NHTSA receives similar complaints, it may open an investigation, and if it finds that a safety defect exists in a group of vehicles, it may order a recall and remedy campaign. However, NHTSA cannot become involved in individual problems between you, your dealer, or NIU. To contact NHTSA, you may call the Vehicle Safety Hotline toll-free at 1-888-327-4236 (TTY: 1-800-424-9153);

go to <http://www.safercar.gov>; or write to:  
Administrator, NHTSA, 400 Seventh Street, SW.,  
Washington, DC 20590.

You can also obtain other information about motor vehicle safety from <http://www.safercar.gov>.

